

ISSN 2217-8139 (Print)
ISSN 2334-0229 (Online)

UDK: 06.055.2:62-03+620.1+624.001.5(497.1)=861



2015.
GODINA
LVIII



GRAĐEVINSKI MATERIJALI I KONSTRUKCIJE

3

BUILDING MATERIALS AND STRUCTURES

ČASOPIS ZA ISTRAŽIVANJA U OBLASTI MATERIJALA I KONSTRUKCIJA
JOURNAL FOR RESEARCH OF MATERIALS AND STRUCTURES



DRUŠTVO ZA ISPITIVANJE I ISTRAŽIVANJE MATERIJALA I KONSTRUKCIJA SRBIJE
SOCIETY FOR MATERIALS AND STRUCTURES TESTING OF SERBIA

GRAĐEVINSKI MATERIJALI I KONSTRUKCIJE

BUILDING MATERIALS AND STRUCTURES

ČASOPIS ZA ISTRAŽIVANJA U OBLASTI MATERIJALA I KONSTRUKCIJA
JOURNAL FOR RESEARCH IN THE FIELD OF MATERIALS AND STRUCTURES

INTERNATIONAL EDITORIAL BOARD

Professor **Radomir Folić**, Editor in-Chief
Faculty of Technical Sciences, University of Novi Sad, Serbia
Fakultet tehničkih nauka, Univerzitet u Novom Sadu, Srbija
e-mail: folic@uns.ac.rs

Professor **Mirjana Malešev**, Deputy editor
Faculty of Technical Sciences, University of Novi Sad,
Serbia - Fakultet tehničkih nauka, Univerzitet u Novom
Sadu, Srbija, e-mail: miram@uns.ac.rs

Dr **Ksenija Janković**
Institute for Testing Materials, Belgrade, Serbia
Institut za ispitivanje materijala, Beograd, Srbija

Dr **Jose Adam, ICITECH**
Department of Construction Engineering, Valencia,
Spain.

Professor **Radu Banchila**
Dep. of Civil Eng. „Politehnica“ University of
Ternisova, Romania

Professor **Dubravka Bjegović**
University of Zagreb, Faculty of Civil Engineering,
Department of Materials, Zagreb, Croatia

Assoc. professor **Meri Cvetkovska**
Faculty of Civil Eng. University "St Kiril and Metodij",
Skopje, Macedonia

Professor **Michael Forde**
University of Edinburgh, Dep. of Environmental Eng.
UK

Dr **Vladimir Gocovski**
Hydro-Quebec, Montreal, Canada

Lektori za srpski jezik: Dr **Miloš Zubac**, profesor
Aleksandra Borojev, profesor
Proofreader: Prof. **Jelisaveta Šafran**, Ph D
Technical editor: Stoja Todorovic, e-mail: saska@imk.grf.bg.ac.rs

Acad. Professor **Yachko Ivanov**
Bulgarian Academy of Sciences, Sofia, Bulgaria

Dr. Habil. **Miklos M. Ivanyi**
UVATERV, Budapest, Hungary

Professor **Asterios Liolios**
Democritus University of Thrace, Faculty of Civil
Eng., Greece

Professor **Doncho Partov**
University of Construction and Architecture - VSU
"LJ.Karavelov" Sofia, Bulgaria

Predrag Popović
Wiss, Janney, Elstner Associates, Northbrook,
Illinois, USA.

Professor **Tom Schanz**
Ruhr University of Bochum, Germany

Professor **Valeriu Stoin**
Dep. of Civil Eng. „Poloitehnica“ University of
Ternisova, Romania

Acad. Professor **Miha Tomažević**, SNB and CEI,
Slovenian Academy of Sciences and Arts,

Professor **Mihailo Trifunac**, Civil Eng.
Department University of Southern California, Los
Angeles, USA

PUBLISHER

Society for Materials and Structures Testing of Serbia, 11000 Belgrade, Kneza Milosa 9
Telephone: 381 11/3242-589; e-mail: dimk@ptt.rs, veb sajt: www.dimk.rs

REVIEWERS: All papers were reviewed

KORICE: Kula INDEKS u Dubai, Ujedinjeni Arapski Emirati, Foster+Partners ((Photo@Nigel
YoungFoster+Partners)

COVER: The INDEKS Dubai, United Arab Emirates, Foster+Partners (Photo@Nigel YoungFoster+Partners)

Financial supports: Ministry of Scientific and Technological Development of the Republic of Serbia

DRUŠTVO ZA ISPITIVANJE I ISTRAŽIVANJE MATERIJALA I KONSTRUKCIJA SRBIJE
SOCIETY FOR MATERIALS AND STRUCTURES TESTING OF SERBIA

GRAĐEVINSKI MATERIJALI I KONSTRUKCIJE

BUILDING MATERIALS AND STRUCTURES

ČASOPIS ZA ISTRAŽIVANJA U OBLASTI MATERIJALA I KONSTRUKCIJA
JOURNAL FOR RESEARCH IN THE FIELD OF MATERIALS AND STRUCTURES

SADRŽAJ

Mladen ĆOSIĆ Radomir FOLIĆ ANALIZA PERFORMANSI OŠTEĆENIH OBJEKATA, PRIMENOM SCENARIJA POVEZANIH NELINEARNIH ANALIZA I KOEFICIJENTA OŠTEĆENJA Originalni naučni rad	3
Alexander TRAYKOV Raina BOIADJIEVA NUMERIČKO MODELIRANJE KONSTRUKCIJA UZ UVOĐENJE FAZA GRAĐENJA I SVOJSTAVA MATERIJALA ZAVISNIH OD VREMENA Prethodno saopštenje.....	29
Jasmina DRAŽIĆ Mirjana LABAN VIŠEKRITERIJUMSKO VREDNOVANJE I IZBOR PROZORA Originalni naučni rad	37
Uputstvo autorima	53

CONTENTS

Mladen COSIC Radomir FOLIC PERFORMANCE ANALYSIS OF DAMAGED BUILDINGS APPLYING SCENARIO OF RELATED NON-LINEAR ANALYSES AND DAMAGE COEFFICIENT Original scientific paper	3
Alexander TRAYKOV Raina BOIADJIEVA COMPUTER MODELLING OF STRUCTURES WITH ACCOUNT OF THE CONSTRUCTION STAGES AND THE TIME DEPENDENT MATERIAL PROPERTIES Preliminary report	29
Jasmina DRAZIC Mirjana LABAN MULTICRITERIA EVALUATION AND WINDOW SELECTION Original scientific paper	37
Preview report	53

CIP - Каталогизacija u publikaciji
Narodna biblioteka Srbije, Beograd

620.1

GRAĐEVINSKI materijali i konstrukcije :
časopis za istraživanja u oblasti materijala
i konstrukcija = Building Materials and
Structures : journal for research of
materials and structures / editor-in-chief
Radomir Folić. - God. 54, br. 1 (2011)-
- Beograd (Kneza Miloša 9) : Društvo za
ispitivanje i istraživanje materijala i
konstrukcija Srbije, 2011- (Novi Beograd :
Hektor print). - 30 cm

Tromesečno. - Je nastavak: Materijali i
konstrukcije = ISSN 0543-0798
ISSN 2217-8139 = Građevinski materijali i
konstrukcije
COBISS.SR-ID 188695820



ANALIZA PERFORMANSI OŠTEĆENIH OBJEKATA, PRIMENOM SCENARIJA POVEZANIH NELINEARNIH ANALIZA I KOEFICIJENTA OŠTEĆENJA

PERFORMANCE ANALYSIS OF DAMAGED BUILDINGS APPLYING SCENARIO OF RELATED NON-LINEAR ANALYSES AND DAMAGE COEFFICIENT

Mladen ČOSIĆ
Radomir FOLIĆ

ORIGINALNI NAUČNI RAD
ORIGINAL SCIENTIFIC PAPER
UDK: 699.844:550.344
doi: 10.5937/grmk1503003C

1 UVOD

Analiza stanja oštećenih objekata predstavlja kompleksan inženjerski problem i zahteva anagažovanje eksperata, tj. inženjera s višegodišnjim iskustvom u proceni stanja objekata. U praksi, početna procena oštećenja objekata najčešće se bazira na empiriji, uz kvalitativan opis stanja objekta, a zatim i kvantitativnoj primeni linearnih numeričkih modela i dimenzionisanja prema propisima. S druge strane, razvoj savremenih softvera za nelinearnu analizu konstrukcija i metodologije projektovanja konstrukcija prema seizmičkim performansama (PBSD) otvara mogućnost za pouzdaniji i multiparametarski pristup u proceni stanja objekata. Generalno razmatrajući, procenu nivoa oštećenja objekata moguće je sprovesti primenom: simplifikovanih analiza, analitičkih procedura, energetske kriterijuma, indeksa oštećenja, proračuna performansi sistema plastičnom analizom (PBPD), krivih osetljivosti, numeričkih jednokoračnih analiza, inkrementalno-iterativnih analiza, nelinearne statičke *pushover* analize (NSPA), nelinearne dinamičke analize (NDA) i inkrementalne nelinearne dinamičke analize (INDA).

Jedan od najčešće korišćenih parametara u oceni stepena oštećenja objekata, za dejstvo zemljotresa, jeste globalni indeks oštećenja [33], [15]. Indikatori oštećenja su nekumulativni, kumulativni i kombinovani. Parametri odgovora koji se koriste za proračun indikatora oštećenja jesu: nivo maksimalnih deformacija sistema, histerezisno ponašanje i apsorpcija energije.

Dr Mladen Čosić, nezavisni istraživač, Marka Milanovića 17, 15300 Loznica, mladen.cosic@gmail.com
Profesor emeritus dr Radomir Folić, Univerzitet u Novom Sadu, Fakultet tehničkih nauka, Trg Dositeja Obradovića 6, 21000 Novi Sad folic@uns.ac.rs

1 INTRODUCTION

The complex engineering problem of analyzing the conditions/state of damaged buildings requires experts i.e. engineers with huge experience in assessing the state of buildings. In practice, the initial assessment of damage to structures is usually empirically-based with a qualitative description of their state, followed by a quantitative description using linear numerical models and dimensioning according to the regulations. However, the latest non-linear structural analysis software and the emerging designing methodologies using *Performance-Based Seismic Design* (PBSD), indicate the possibility for reliable and multi-parameter approach in assessing the state of the structure. Generally, the level of damage to structures can be assessed based on the following: simplified analysis, analytical procedures, energy criteria, damage index, calculating system performance using *Performance-Based Plastic Design* (PBPD), fragility curves, numerical one step solution, incremental-iterative analysis, *Non-linear Static Pushover Analysis* (NSPA), *Non-linear Dynamic Analysis* (NDA) and *Incremental Non-linear Dynamic Analysis* (INDA).

One of the most common parameters used in assessing structural damage levels induced by earthquake action is the global damage index [33] and [15]. Damage indicators can be non-cumulative, cumulative and combined. Response parameters used for calculating the damage indicators are the following: maximum system deformation level, hysteresis behaviour and energy

Dr Mladen Čosić, independent scientist, Marka Milanovića 17, 15300 Loznica, mladen.cosic@gmail.com
Professor emeritus Dr Radomir Folić, University of Novi Sad, Faculty of Technical Sciences, Trg Dositeja Obradovića 6, 21000 Novi Sad folic@uns.ac.rs

Globalni indeksi oštećenja jesu: prosečni težinski indeksi [28], [29], [5] i indeksi određeni na osnovu modalnih parametara [30], [7]. Unapređeni indeks oštećenja 2D modela zgrada prikazan je u [20], dok je u [19] prikazan indeks oštećenja za 3D modele zgrada. Procena nivoa oštećenja zgrada, na osnovu rezidualnog seizmičkog kapaciteta, razmatrana je u radu [25]. Klase oštećenja usvojene su prema [27]: prvi nivo oštećenja - počev od iniciranja prslina do pojave napona tečenja u šipkama armature; drugi i treći nivo oštećenja do iniciranja loma pri pritisku u betonu; četvrti nivo do izvijanja podužnih šipki armature i odlamanja zaštitnog sloja betona; peti nivo - do potpunog kolapsa konstrukcije. Istraživanje na temu kontrolisanog mehanizma loma sistema, proračunom prema silama (FBD), prezentovano je u [26]. Primenom energetskog koncepta i metode spektra odgovora za nivo granice tečenja (YPS), razmatrane su funkcije oštećenja zgrada preko: faktora modifikacije pomeranja, faktora redukcije nosivosti na granici tečenja, parametra seizmičke energije, indeksa oštećenja, koeficijenta ekvivalentne duktilnosti [24]. Razmatranje mogućnosti razvoja različitih mehanizama loma okvirnih sistema zgrada (MRF) - od spratnog do kombinovanog - prikazano je u radu [31], dok je u radovima [1], [2] izvršena identifikacija kolapsnog mehanizma loma sistema na osnovu spektra kapaciteta kolapsa. Generalna podela razvoja mehanizma loma sistema jeste na lokalni i globalni. U radu [22] prikazani su primeri zgrada gde su, usled dejstva zemljotresa, razvijeni spratni (lokalni) mehanizmi loma s potpunim kolapsom i bez njega. Takođe, ukazano je i na formiranje mehanizma loma po svim spratovima (globalnog), bez potpunog kolapsa zgrade. U istraživanju [32], iniciranje mehanizma kolapsa zgrada i globalne dinamičke nestabilnosti sistema razmatrano je u funkciji međuspratnog drifta i spektralnih akceleracija primenom inkrementalne dinamičke analize (IDA). Takođe, mnogi rezultati istraživanja na temu mehanizama oštećenja i loma zgrada IDA analizom u kapacitivnom domenu prikazani su u [4], [16], [17], [21].

U ovom radu predstavljena je procedura kojom se simulacijom - putem scenarija međusobno povezanih analiza - doprinosi uvidu o stanju, a koja je važna za odluku o neophodnim intervencijama ili uklanjanju to jest rušenju konstrukcije. Na primeru armiranobetonske zgrade s deset etaža, prikazana je razvijena procedura kojom se u incidentnoj situaciji utvrđuje adaptabilnost sistema, koji je i dodatno izložen dejstvu zemljotresa. S obzirom na to što se prema PBSM metodologiji razmatraju performanse sistema, primenom nelinearnih numeričkih modela, dovodeći ga do stanja pretkolapsa, odnosno kolapsa, to se primenom ovako razvijene procedure mogu pouzdano donositi odluke o stanju zgrade.

2 SCENARIO POVEZANIH NELINEARNIH ANALIZA

Koncept scenarija povezanih nelinearnih analiza, razvijeni i prikazani u ovom istraživanju i u [14], zasniva se na utvrđivanju stanja objekta, uvažavajući principe projektovanja konstrukcija prema seizmičkim performansama (PBSM). Klasičan pristup u proceni stanja oštećenog objekta polazi od nedestruktivnih metoda, uzimanja uzoraka, empirijskim procenama i proračunom objekata primenom linearnih analiza.

Global damage indices include average weight indices [28], [29], [5] and indices identified based on modal parameters [30] and [7]. The improved damage index for 2D building models is presented in [20], while [19] discusses the damage index for 3D models. The assessment of damage levels to buildings based on the residual seismic capacity is discussed in [25]. Damage classes have been adopted according to [27]: the first level of damage between cracks initiation and appearance of yield in reinforcement bars, the second and third level of damage before the initiation of pressure-induced concrete fracture, the fourth level before the buckling of longitudinal reinforcement bars and spalling off of the protective concrete layer, and the fifth level up to the collapse of the building. The research regarding the system's controlled fracture mechanism using the *Force-Based Design* (FBD) is presented in [26]. Applying the energy concept and the *Yield Point Spectra Method* the structures' damage functions were considered using: the displacement modification factor, yield strength reduction factor, seismic energy response parameter, damage index and equivalent ductility ratio [24]. Possibilities of developing various fracture mechanisms in the moment resisting frame (MRF), both in storey and combined levels, are shown in [31], while in [1] and [2] the collapse mechanism of system fracture are identified on the basis of collapse capacity spectra. Generally, the system's fracture mechanism can develop locally or globally. In [22] examples of buildings are presented where earthquake-induced storey-level (local) fracture mechanisms occurred with and without a total collapse. The formation of fracture mechanism along all storeys (global) without the building's total collapse is also indicated. Initiation of the collapse mechanism and the system's global dynamic instability were discussed in [32] as a function of inter-storey drifts and spectral acceleration using the IDA analysis. A number of results on damage and fracture mechanisms obtained using IDA analysis in capacitive domain are presented in [4], [16], [17] and [21].

This paper describes a procedure of simulating the scenarios of interrelated analyses, providing thereby a better insight in the state of the building and facilitating decisions on necessary interventions or the removal/demolition of the building. On the example of a ten storey reinforced concrete building, a procedure has been developed for determining the adaptability in accidental situations of the system additionally exposed to earthquake actions. Given the fact that the PBSM methodology requires system performance to be considered using non-linear numerical models bringing the system into a pre-collapse or collapse state, these advanced procedures enable the aforementioned decisions about the building to be highly reliable.

2 SCENARIO OF RELATED NON-LINEAR ANALYSES

The concept of the scenario of related non-linear analyses, presented in this research and in [14], is based on determining the structural condition while observing the *Performance-Based Seismic Design* (PBSM) principles. The classical approach in the assessment of a damaged structure starts from the non-destructive methods, sample taking, empirical

Proračun graničnih stanja nosivosti i upotrebljivosti sprovodi se prema propisima, pri čemu prednost treba dati modernim evropskim propisima EN 1992 [8] i EN 1998 [9]. Međutim, ovi propisi ne definišu detaljno oblasti u kojima se razmatraju objekti koji su u toku svog eksploatacionog veka oštećeni incidentnim dejstvima, kao što je dejstvo projektila (objekti bombardovani u Srbiji 1999. godine), nagli kolaps jednog ili nekoliko konstruktivnih elemenata i slične incidentne situacije. Takođe, znatan broj objekata nakon dejstva snažnog zemljotresa ne sanira se u predviđenom periodu, pa budu izloženi ili naknadnim zemljotresima manjih intenziteta ili afteršokovima koji mogu dodatno ugroziti nosivost, stabilnosti i upotrebljivost već oštećenog objekta [23]. Slična situacija je i sa objektima koji su bombardovani u Srbiji 1999. godine. Neki od ovih objekata i do danas nisu sanirani, tako da u postojećem oštećenom obliku dodatno predstavljaju opasnost za korisnike ili prolaznike koji se kreću u njihovoj neposrednoj blizini.

Aspekti na koje ukazuju evropski propisi pri proračunu oštećenih objekata uglavnom se odnose na primenu linearnih statičkih analiza i dimenzionisanja armiranobetonskih elemenata. Procedure koje definišu nelinearne analize objekata svedene su na minimum. U odnosu na evropske propise, američki propisi FEMA 273 [11], FEMA 274 [12] i FEMA 356 [13] detaljnije razmatraju procene stanja i sanacije objekata koji su izloženi dejstvu zemljotresa. Međutim, ne uzimaju se u obzir druga incidentna dejstva i povezanost numeričkih modela pre i posle oštećenja. S ciljem jasnijeg definisanja i tačnijeg proračuna ovako složenog problema, razvijen je scenario povezanih nelinearnih analiza, koji je potrebno sprovesti kako bi se mogle doneti kvalitetne odluke o stanju objekta. Na slici 1 prikazan je dijagram toka scenarija povezanih nelinearnih analiza. U prvom delu sprovodi se proračun, primenom linearne statičke analize (LSA) i spektralne-modalne analize (SMA). Zatim, dimenzionisanjem prema EN 1992 [8] i EN 1998 [9] propisima određuje se potrebna armatura u armiranobetonskim presecima. U drugom delu se kreira nov 3D model objekta za nelinearne analize. U prvom koraku drugog dela proračunavaju se statički uticaji u presecima objekata samo za vertikalna gravitaciona dejstva (stalno, korisno i slična opterećenja). Matrica krutosti sistema na kraju ove analize koristi se kao inicijalna matrica krutosti prilikom nelinearne statičke *pushover* analize (NSPA) za bidirekciono seizmičko dejstvo (X i Y pravac), koja se sprovodi u drugom koraku drugog dela. Kao nelinearni odgovor sistema, dobijaju se *pushover* krive, ciljno pomeranje, sile i momenti u presecima, globalni (*DR*) i međuspratni driftovi (*IDR*). U trećem delu sprovodi se simulacija incidentnog dejstva na konstrukciji, pri čemu nastupa oštećenje objekta redukcijom nosivosti, stabilnosti i upotrebljivosti pojedinih stubova. Matrica krutosti sistema prethodne analize koristi se kao inicijalna matrica krutosti nelinearne analize (NA - *Nonlinear Analysis*) kojom se simulira oštećenje objekta. Matematička formulacija analize incidentnog dejstva izvedena je polazeći od izraza za stanje neoštećenog objekta:

assessment and design of structures using linear analyses. The ultimate limit state and service life calculations are conducted according to the regulations, with contemporary European codes EN 1992 [8] and EN 1998 [9] being primary. However, these codes fail to define in detail the areas in which the buildings are considered, which were damaged during their service life by accidental action, such as the effects of the projectiles (structures in Serbia bombed in 1999), sudden collapse of one or several structural elements and similar accidental situations. Also, a significant number of buildings upon the impact of a strong earthquake are unrepaired within the prescribed period and thus exposed to either subsequent earthquakes of smaller intensity or aftershocks which can be further impair of the bearing capacity, stability and usability on the already damaged building [23]. The situation is similar with buildings that were bombed in Serbia in 1999. A number of these structures are still unrepaired, and thus, their existing damaged state additionally endangers their users or pedestrians in their immediate vicinity.

Aspects indicated by the European regulations listed in the calculation of damaged buildings are mostly related to the use of linear static analyses and dimensioning reinforced concrete elements. The procedures defining the non-linear analyses of structures are minimized. In comparison to the European regulations, the American regulations FEMA 273 [11], FEMA 274 [12] and FEMA 356 [13] consider the assessments of conditions and rehabilitation of the structures, which were exposed to earthquake action in detail. However, they fail to take into consideration other accidental actions and relatedness of numerical models before and after sustaining damage. For the purpose of clearer defining and more accurate calculation of such complex problem, the scenario of related non-linear analyses is developed, which must be performed in order to make adequate decisions on the condition of the structure. A flow chart of scenarios of the related non-linear analyses is presented in Figure 1. In the first part, the calculation is conducted implementing the *Linear Static Analysis* (LSA) and *Spectral - Modal Analysis* (SMA). Further, by designing in compliance with EN 1992 [8] and EN 1998 [9] codes, the necessary reinforcement in RC cross-sections is determined. In the second part a new 3D model of building is created for the non-linear analysis. At the first step of the second part, the static effects in the cross-sections of the structures are calculated only for vertical gravity actions (dead, super dead, live and similar loads). At the end of this analysis the system stiffness matrix is used as the initial stiffness matrix in the *Non-linear Static Pushover Analysis* (NSPA) for bidirectional seismic action (X and Y directions), which is conducted in the second step of the second part. As a non-linear response of the system the pushover curves, target displacement, forces and moments in cross sections, global drift (*DR*) and inter-storey drifts (*IDR*) are obtained. In the third part, the simulation of accidental action on the structure is conducted, so the action causing decreases of bearing capacity, stability and serviceability of individual columns. The system stiffness matrix of the previous analysis is used as initial stiffness matrix of the non-linear analysis (NA) which simulates structural damage.

The mathematical formulation for analyzing accidental action is derived based on the expression for the state of the undamaged building:

$$[K_0]\{D_0\} = \{P_0\}, \quad (1)$$

gde je $[K_0]$ matrica krutosti neoštećenog objekta, $\{D_0\}$ vektor pomeranja neoštećenog objekta i $\{P_0\}$ vektor opterećenja neoštećenog objekta. Za i -ti scenario oštećenja analiza se sprovodi prema:

$$[K_i]\{D_i\} = \{P_i\}, \quad [K_i] = [K_0] - [K'_i], \quad [M_i] = [M_0] - [M'_i], \quad (2)$$

gde je $[K_i]$ matrica krutosti oštećenog objekta, $\{D_i\}$ vektor pomeranja oštećenog objekta, $\{P_i\}$ vektor opterećenja oštećenog objekta, $[K'_i]$ matrica krutosti eliminisanih stubova, $[M_i]$ matrica masa oštećenog objekta, $[M_0]$ matrica masa neoštećenog objekta i $[M'_i]$ matrica masa eliminisanih stubova.

U ovom slučaju može se pratiti razvoj nelinearnih deformacija i preraspodela statičkih uticaja u sistemu. Posebno je interesantno to što se ovakvom analizom može sprovoditi monitoring plastičnih defomacija u zoni jako oštećenih stubova, odnosno monitoring razvoja plastičnih zglobova na gredama koje su pozicionirane u zoni lokalnog kolapsa. Broj mogućih scenarija n oštećenja objekta i kolapsa pojedinih stubova može biti znatan. U četvrtom delu matrica krutosti sistema na kraju analize oštećenja objekta koristi se kao inicijalna matrica krutosti NSPA analize za bidirekciono seizmičko dejstvo (X i Y pravac), pri čemu se kao nelinearni odgovori sistema dobijaju *pushover* krive, ciljno pomeranje, sile i momenti u preseccima, globalni *DR* i međuspratni *IDR* driftovi. U petom delu se proračunava koeficijent oštećenja C_d za svaki scenario i seizmičko dejstvo (X i Y pravac) pojedinačno. Po završetku proračuna objekta po svim predefinisanim scenarijima, a na osnovu proračunatih *pushover* krivih, globalnih *DR* i međuspratnih *IDR* driftova, kriviranih mehanizama loma sistema i koeficijenata oštećenja C_d , utvrđuje se da li je potrebno objekat sanirati, pojačati ili delimično promeniti statički sistem u zoni kolapsa stubova. Ukoliko je potrebno sprovesti neki od predloženih postupaka, tada se redimenzioniše objekat i eventualno ponavlja procedura radi verifikacije i komparacije dobijenih rešenja. Kao što se može primetiti, ovako koncipiranim proračunom oštećenog objekta simulira se realistično ponašanje u uslovima dejstva i incidentne situacije i seizmičkog dejstva, budući da se prvo objekat izloži dejstvu gravitacionog opterećenja, a zatim se ovako opterećena konstrukcija izlaže incidentnom dejstvu. Nakon toga, povredljivost objekta proverava se na deformisanom i oštećenom objektu, dok se kroz sve proračune gravitaciono opterećenje samo prenosi iz početne u naredne analize, a incidentno i seizmičko dejstvo se definiše u njima odgovarajućim analizama.

Tekst uz sl. 1 nije preveden na srpski jezik jer je obrazložen u tekstu.

where $[K_0]$ is the stiffness matrix of the undamaged building, $\{D_0\}$ is the displacement vector of the undamaged building and $\{P_0\}$ is the load vector of the undamaged building. For the i -th damage scenario, the analysis is conducted based on:

where $[K_i]$ is the stiffness matrix of the damaged building, $\{D_i\}$ is the displacement vector of the damaged building, $\{P_i\}$ is the load vector of the damaged building, $[K'_i]$ is the stiffness matrix of eliminated columns, $[M_i]$ is the mass matrix of the damaged building, $[M_0]$ is the mass matrix of the undamaged building and $[M'_i]$ is the mass matrix of eliminated columns.

In this case, development of non-linear strains in the system can be monitored, as well as the redistribution of static influences in the system. It is of particular importance that such analysis can serve for monitoring plastic strain in the zone of severely damaged columns, i.e. monitoring development of plastic hinges on the beams that are located in the local collapse zone. The number of possible scenarios n of structural damage and collapse of individual columns can be considerable. In the fourth part, the system stiffness matrix at the end of the structural damage analysis is used as initial stiffness matrix of NSPA analysis for bidirectional seismic action (X and Y direction), whereby the pushover curves are obtained as non-linear responses of the system, as well as target displacement, forces and moments in cross-sections, global *DR* and inter-storey drifts *IDR*. In the fifth section, the damage coefficient C_d has been calculated for each scenario and seismic action (X and Y directions) individually. Decisions regarding the possible need for repairing, reinforcing or partially changing the static system of the building in the zone of collapsed columns are made based on calculated pushover curves, global *DR* and inter-storey *IDR* drifts, established fracture mechanisms and damage coefficient C_d upon the completion of the calculation on all pre-defined scenarios. If it is necessary to conduct some of the proposed procedures, the structure is redesigned, and possibly the procedure is reiterated for the purpose of verification and comparison of the obtained solutions. As it can be noticed, the calculation of the damaged structure conceived in this manner, simulates the realistic behaviour in the conditions of action and of accidental situation and seismic actions, by firstly exposing the structure to the action of the gravitational load, and then by exposing the structure loaded in this way to the accidental action. After that, the vulnerability of the structure is verified on the deformed and damaged structure, while the gravitational load is just transferred from the initial analysis to the following ones and the accidental and seismic action are defined in the corresponding analyses.

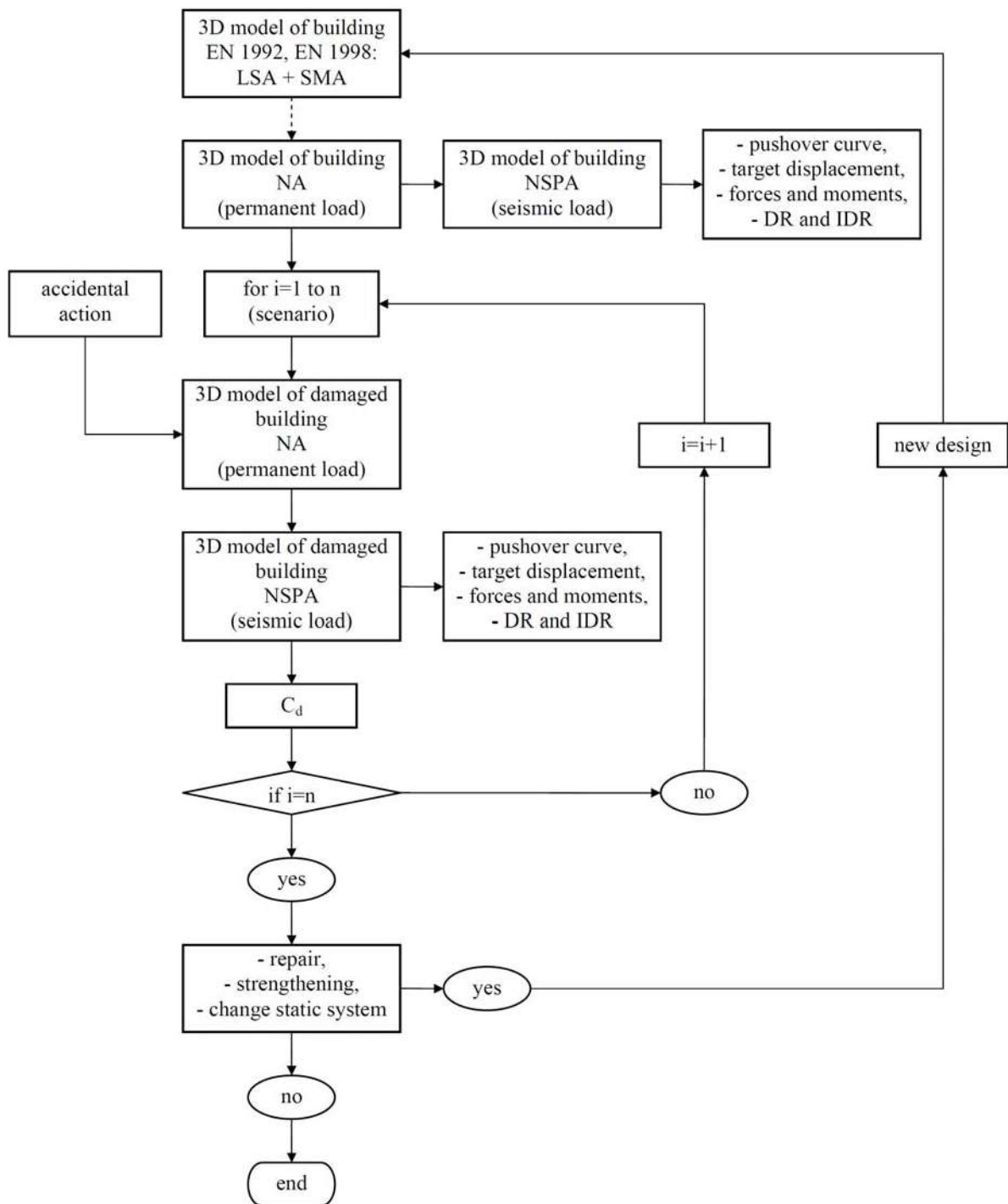

Slika 1. Dijagram toka scenarija povezanih nelinearnih analiza
Figure 1. Flow chart of scenarios of the related non-linear analyses

3 KOEFICIJENT OŠTEĆENJA

Razmatranje stepena oštećenja objekta izloženog incidentnom i seizmičkom dejstvu sprovedeno je uvođenjem novog koeficijenta oštećenja C_d . Ovim koeficijentom sprovodi se uporedna analiza neoštećenog i oštećenog objekta. U odnosu na postojeće indekse oštećenja, koji se zasnivaju na analizi stepena oštećenja objekta izloženog seizmičkom dejstvu i razmatranja odgovora

3 DAMAGE COEFFICIENT

Considerations regarding the degree of damage to the building exposed to accidental and seismic actions were carried out by introducing the damage coefficient C_d . This is the coefficient based on which a comparative analysis between the undamaged and the damaged building is carried out. Unlike the existing damage indices, which are based on analyzing the degree of

sistema u vremenskom domenu, primenom koeficijenta oštećenja C_d razmatra se odgovor sistema u kapacitativnom domenu. U tom smislu se i dobija potpunija slika o stepenu oštećenja objekta, jer se razmatra sistem od inicijalnog elastičnog stanja preko nelinearnog, pa sve do kolapsnog stanja. S druge strane, razmatranjem stepena oštećenja objekta u kapacitativnom domenu, a primenom koeficijenta oštećenja C_d , moguće je obuhvatiti sve nivoe seizmičkog zahteva koji se postavljaju pred konstrukciju. Kada se razmatranje stepena oštećenja sprovodi preko ustaljenih indeksa oštećenja u vremenskom domenu, moguće je istraživanje sprovoditi samo za jedan nivo seizmičkog zahteva. Izraz kojim je uveden koeficijent oštećenja C_d zasniva se na uporednoj analizi *pushover* krive neoštećenog i oštećenog objekta. Oštećenja objekta, kao što je već napomenuto, nastaju usled dejstva incidentne situacije i usled seizmičkog dejstva. Za potrebe ovog istraživanja, a dovoljno pouzdano da se može primeniti u slučaju gotovo svih nelinearnih odgovora višespratnih zgrada, definicija koeficijenta oštećenja C_d bazira se na modelu trilinearne *pushover* krive. *Pushover* krive realnih modela zgrada dobijaju se konekcijom većeg broja diskretnih vrednosti iz inkrementalnih nelinearnih situacija. Konekcija se sprovodi primenom linearne ili splajn interpolacije, tako da u ovom drugom slučaju *pushover* kriva ostavlja utisak glatke krive. Primenom modela trilinearne *pushover* krive, može se ili trilinearizovati *pushover* kriva realnog modela zgrade ili se iz *pushover* krive realnog modela zgrade mogu odrediti ključni parametri koji se koriste kao inputi za model trilinearne *pushover* krive. Na slici 2a prikazan je model trilinearne *pushover* krive čije su diskretne vrednosti linearno interpolirane, dok je na slici 2b prikazan isti model trilinearne *pushover* krive čije su diskretne vrednosti splajnom interpolirane. Međusobno odstupanje linearno i splajn interpolirane *pushover* krive realnog modela zgrade znatno je manje, s obzirom na to što se ove krive, kao što je već rečeno, dobijaju konekcijom većeg broja diskretnih vrednosti iz inkrementalnih nelinearnih situacija.

damage to the building subjected to seismic action and considering the system response in the time domain, the damage coefficient C_d approach considers the system response in the capacitive domain. Thus, a more complete picture can be obtained of the damage degree to the building, since it considers the system from its initial state through the non-linear elastic state to the collapse state. However, when considering the damage degree in the capacitive domain using the damage coefficient C_d , it is possible to cover all levels of seismic demand imposed to the structure. When considering the damage degree based on the usual damage indices in the time domain, only a single level of seismic demand can be taken into consideration. The term on which the damage coefficient C_d was introduced is based on the comparative analysis of pushover curves of the undamaged and damaged building. Damage to the building, as already mentioned, are due to the action of an accidental situation and seismic action. For the purposes of this study, the damage coefficient C_d is defined based on the tri-linear pushover curve model, the reliability of which is sufficient to be applied in almost all non-linear responses of multi-storey buildings. Pushover curves of real building models are obtained by connecting a number of discrete values derived from incremental non-linear situations. The connection is carried out by using linear or spline interpolation, so that in the latter case the pushover curve leaves the impression of a smooth curve. Applying the tri-linear pushover curve model enables either to tri-linearize the pushover curve of the real building model or to take the pushover curve of the real building model as a basis for identifying the key parameters used as inputs for the tri-linear pushover curve model. Figure 2a shows the tri-linear pushover curve model whose discrete values are linearly interpolated, while Figure 2b shows the same tri-linear pushover curve model whose discrete values are spline interpolated. The deviation between the linear and spline interpolated pushover curve of the real building model is much lower, since these curves, as already mentioned, are obtained by connecting a number of discrete values of incremental non-linear situations.

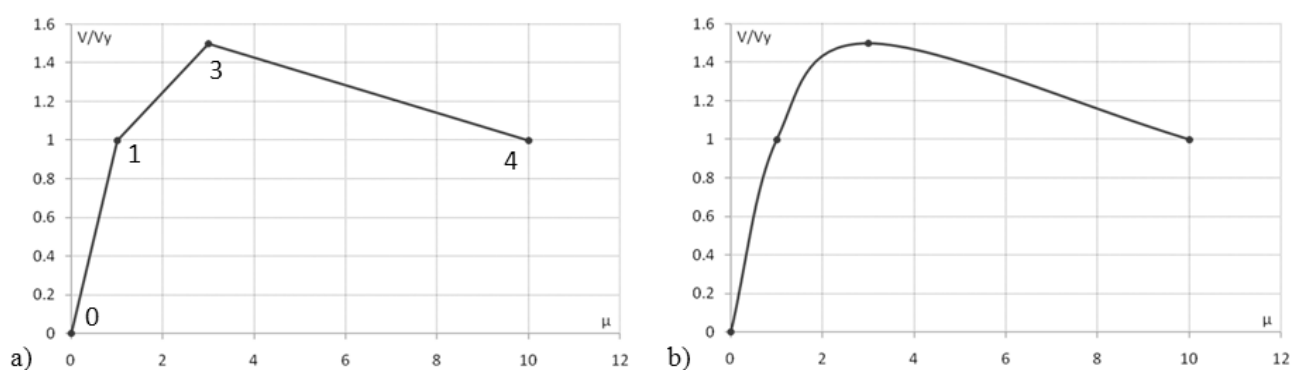

Slika 2. a) model trilinearne *pushover* krive čije su diskretne vrednosti linearno interpolirane, b) model trilinearne *pushover* krive čije su diskretne vrednosti splajnom interpolirane

Figure 2. a) tri-linear pushover curve model whose discrete values are linearly interpolated, b) tri-linear pushover curve model whose discrete values are spline interpolated

S ciljem sprovođenja parametarske analize, *pushover* krive su definisane u funkciji koeficijenta duktilnosti μ i odnosa ukupne smičuće sile u osnovi objekta i ukupne smičuće sile u osnovi objekta na granici tečenja V/V_y (relativna ukupna smičuća sila u osnovi objekta). Merodavni parametri modela trilinearne *pushover* krive jesu:

- čvor 1: $0 \leq \mu_0 < 1$, $0 \leq (V/V_y)_0 < 1$,
- Kao posledica prethodnog incidentnog ili seizmičkog dejstva, inicijalni koeficijent duktilnosti μ_0 i inicijalna relativna ukupna smičuća sila u osnovi objekta $(V/V_y)_0$ mogu biti različiti (veći) od nule, a manji od 1.
- čvor 2: $\mu_y = 1$, $(V/V_y)_y = 1$,
- Koeficijent duktilnosti na granici tečenja μ_y i relativna ukupna smičuća sila u osnovi objekta na granici tečenja $(V/V_y)_y$ su uvek jednake 1.
- čvor 3: $1 < \mu_{h/s} < \mu_{max}$, $(V/V_y)_{h/s} > 0$,
- Koeficijent duktilnosti za nivo ojačanja/omekšanja $\mu_{h/s}$ uvek je veći od 1, a manji od koeficijenta maksimalno realizovane duktilnosti μ_{max} , dok je relativna ukupna smičuća sila u osnovi objekta za nivo ojačanja/omekšanja $(V/V_y)_{h/s}$ veća od 0.
- čvor 4: $\mu_{max} > 1$, $(V/V_y)_{adeq} \geq 0$,
- Koeficijent maksimalno realizovane duktilnosti μ_{max} uvek je veći od 1, dok je odgovarajuća relativna ukupna smičuća sila u osnovi objekta $(V/V_y)_{adeq}$ veća ili eventualno jednaka 0.

Koeficijent oštećenja C_d definisan je uglavnom u funkciji apsolutnih vrednosti koordinata, ali se, radi sprovođenja parametarske analize, dijagrami *pushover* krivih prikazuju u funkciji relativnih vrednosti koordinata. Uvažavajući prethodno izvedene stavove o ključnim parametrima trilinearne *pushover* krive, ali prevedeni u apsolutne vrednosti koordinata, izveden je koeficijent oštećenja C_d i koji glasi:

$$C_d = \left| 1 - 0.125 \left[\frac{\int_0^{D_{maxd}} V_d(D_d) dD}{\int_0^{D_{maxu}} V_u(D_u) dD} + \frac{K_{i,d}}{K_{i,u}} + \frac{K_{n,d}}{K_{n,u}} + \frac{V_{y,d}}{V_{y,u}} + \frac{V_{h/s,d}}{V_{h/s,u}} + \frac{D_{maxd}}{D_{maxu}} + \frac{V_{adeq,d}}{V_{adeq,u}} + \frac{\mu_{maxd}}{\mu_{maxu}} \right] \right|. \quad (3)$$

Koeficijent oštećenja C_d sastoji se iz osam bitnih faktora kojim se definiše stepen oštećenja objekta komparacijom *pushover* krive neoštećenog i oštećenog objekta:

- utvrđivanje stepena oštećenja preko odnosa površi *pushover* krivih neoštećenog $\int V_u(D_u) dD$ i oštećenog objekta $\int V_d(D_d) dD$;
- utvrđivanje stepena oštećenja preko odnosa inicijalne krutosti neoštećenog $K_{i,u}$ i oštećenog objekta $K_{i,d}$;
- utvrđivanje stepena oštećenja preko odnosa nelinearne krutosti neoštećenog $K_{n,u}$ i oštećenog objekta $K_{n,d}$;
- utvrđivanje stepena oštećenja preko odnosa ukupne smičuće sile u osnovi objekta na granici tečenja neoštećenog $V_{y,u}$ i oštećenog objekta $V_{y,d}$;
- utvrđivanje stepena oštećenja preko odnosa ukupne smičuće sile u osnovi objekta za nivo ojačanja/omekšanja neoštećenog $V_{h/s,u}$ i oštećenog

In order to conduct the parametric analysis, *pushover* curves are defined as a function of ductility coefficient μ and the ratio of the total base shear force of the building and the total base shear force of the building at the yield limit V/V_y (the relative total base shear force of the building). Parameters relevant to the tri-linear *pushover* curve model are the following:

- node 1: $0 \leq \mu_0 < 1$, $0 \leq (V/V_y)_0 < 1$,
- As a consequence of the previous accidental or seismic action, the initial ductility coefficient μ_0 and the initial relative total base shear force of the building $(V/V_y)_0$ can be non-zero, i.e. larger than zero and lower than 1.
- node 2: $\mu_y = 1$, $(V/V_y)_y = 1$,
- The ductility coefficient at the yield limit μ_y and the relative total base shear force of the building at the yield limit $(V/V_y)_y$ are always equal to 1.
- node 3: $1 < \mu_{h/s} < \mu_{max}$, $(V/V_y)_{h/s} > 0$,
- The ductility coefficient for the level of hardening/softening $\mu_{h/s}$ is always higher than 1 and lower than the coefficient of maximum realized ductility μ_{max} , while the relative total base shear force of the building for the level of hardening/softening $(V/V_y)_{h/s}$ is higher than 0.
- node 4: $\mu_{max} > 1$, $(V/V_y)_{adeq} \geq 0$,
- The coefficient of the maximum realized ductility μ_{max} is always higher than 1, while the adequate relative total base shear force of the building $(V/V_y)_{adeq}$ is higher or equal to 0.

The damage coefficient C_d is generally defined as a function of absolute coordinate values, but for the purpose of parametric analysis, diagrams of *pushover* curves are presented as a function of relative coordinate values. Taking into account the previously derived positions on key parameters of the tri-linear *pushover* curve, but translated into absolute coordinate values, the following damage coefficient C_d is derived:

The damage coefficient C_d consists of eight important factors defining the degree of damage to the building by comparing the *pushover* curves of the undamaged and damaged building:

- determining the degree of damage based on the ratio of the *pushover* curve surface of the undamaged $\int V_u(D_u) dD$ and the damaged building $\int V_d(D_d) dD$,
- determining the degree of damage based on the ratio of initial stiffness of the undamaged $K_{i,u}$ and the damaged building $K_{i,d}$,
- determining the degree of damage based on the ratio of non-linear stiffness of the undamaged $K_{n,u}$ and the damaged building $K_{n,d}$,
- determining the degree of damage based on the ratio of the total base shear force at the yield limit of the undamaged building $V_{y,u}$ and the damaged building $V_{y,d}$,
- determining the degree of damage based on the ratio of the total base shear force of the building for the level of hardening/softening of the undamaged $V_{h/s,u}$ and

objekta $V_{h/s,d}$;

– utvrđivanje stepena oštećenja preko odnosa maksimalno realizovanog pomeranja neoštećenog $D_{max,u}$ i oštećenog objekta $D_{max,d}$;

– utvrđivanje stepena oštećenja preko odnosa odgovarajuće ukupne smičuće sile u osnovi objekta za maksimalno realizovano pomeranje neoštećenog $(V/V_y)_{adeq,u}$ i oštećenog objekta $(V/V_y)_{adeq,d}$;

– utvrđivanje stepena oštećenja preko odnosa maksimalno realizovanog koeficijenta duktilnosti neoštećenog $\mu_{max,u}$ i oštećenog objekta $\mu_{max,d}$.

Na slici 3 prikazane su *pushover* krive i koeficijenti oštećenja C_d određeni parametarskom analizom, a na osnovu prethodno definisanih parametara. Vrednosti koeficijenti oštećenja su u intervalu $C_d=[0,100]$ i prikazani su u procentima. Ukoliko je koeficijent oštećenja $C_d=0\%$, tada je objekat neoštećen, a ukoliko je koeficijent oštećenja $C_d=100\%$, tada je objekat potpuno oštećen to jest urušen. Povećanjem inicijalnog koeficijenta duktilnosti μ_0 koeficijent oštećenja C_d se malo povećava, u odnosu na model neoštećene zgrade, tako da je čak i pri vrednosti $\mu_0=1$ koeficijent oštećenja $C_d=0,6\%$ (slika 3a). S druge strane, povećanjem inicijalne relativne ukupne smičuće sile u osnovi objekta do $(V/V_y)_0=0,6$, koeficijent oštećenja povećava se do $C_d=7,5\%$ (slika 3b), tako da se može konstatovati da je koeficijent oštećenja C_d znatno osetljiviji pri promeni inicijalne relativne ukupne smičuće sile u osnovi objekta $(V/V_y)_0$, nego pri promeni inicijalnog koeficijenta duktilnosti μ_0 . Povećanjem koeficijenta duktilnosti na granici tečenja na $\mu_y=2$ oštećenog objekta, koeficijent oštećenja se povećava do $C_d=13,2\%$ (slika 3c), a redukcijom relativne ukupne smičuće sile u osnovi objekta na granici tečenja do $(V/V_y)_y=0,4$, koeficijent oštećenja se povećava do $C_d=16,1\%$ (slika 3d).

damaged building $V_{h/s,d}$,

– determining the degree of damage based on the ratio of maximum realized displacement on undamaged $D_{max,u}$ and damaged building $D_{max,d}$,

– determining the degree of damage based on the ratio of the adequate total base shear force of the building for the maximum realized displacement in the undamaged $(V/V_y)_{adeq,u}$ and the damaged building $(V/V_y)_{adeq,d}$,

– determining the degree of damage based on the ratio of maximum realized ductility coefficient in the undamaged $\mu_{max,u}$ and damaged building, $\mu_{max,d}$.

Figure 3 shows the pushover curves and damage coefficients C_d obtained by parametric analysis and based on the pre-defined parameters. The damage coefficient values are in the interval of $C_d=[0,100]$ and they are shown in percentages. If the damage coefficient is $C_d=0\%$, then the building is undamaged; if the damage coefficient is $C_d=100\%$, then the building suffers total damage - it collapses. By increasing the initial coefficient of ductility μ_0 , the damage coefficient C_d slightly increases as compared to the undamaged building model, so that even with $\mu_0=1$, the damage coefficient is $C_d=0.6\%$ (Figure 3a). However, increasing the initial relative total base shear force of the building to $(V/V_y)_0=0.6$, the damage coefficient increases to $C_d=7.5\%$ (Figure 3b), so it can be concluded that the sensitivity of the damage coefficient C_d is significantly higher when changing the initial relative total base shear force of the building $(V/V_y)_0$ in comparison with changing initial coefficient of ductility μ_0 . By increasing the coefficient of ductility at the yield limit to $\mu_y=2$ of the damaged building, the damage coefficient increases to $C_d=13.2\%$ (Figure 3c), while by reducing the relative total base shear force of the building at yield limit to $(V/V_y)_y=0.4$, the damage coefficient increases to $C_d=16.1\%$ (Figure 3d).

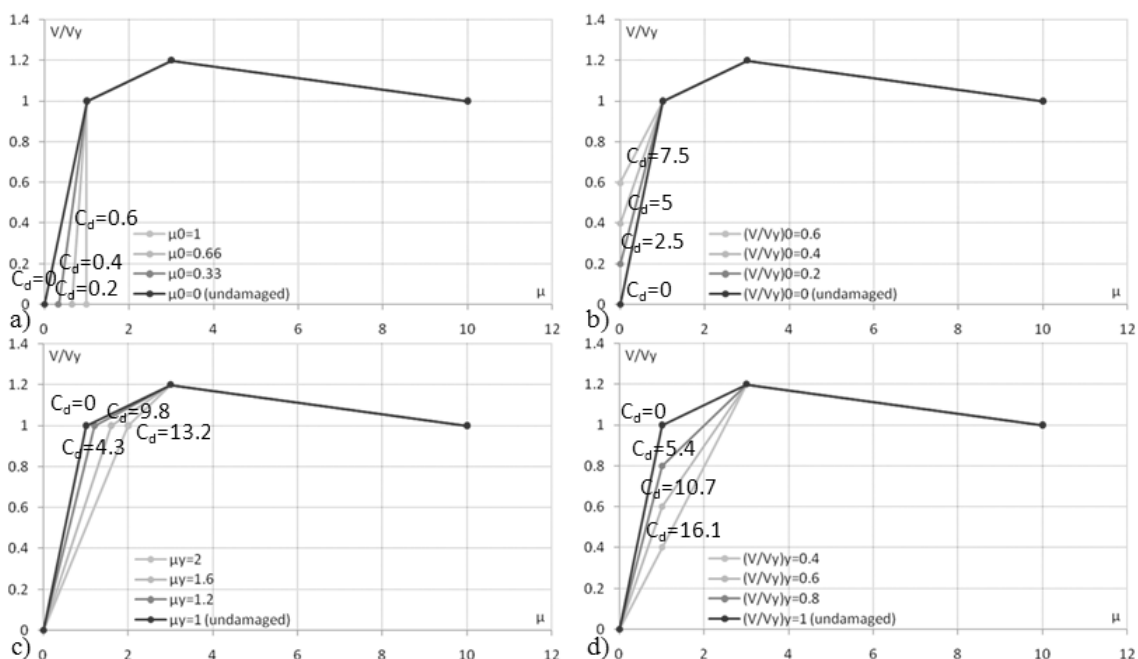

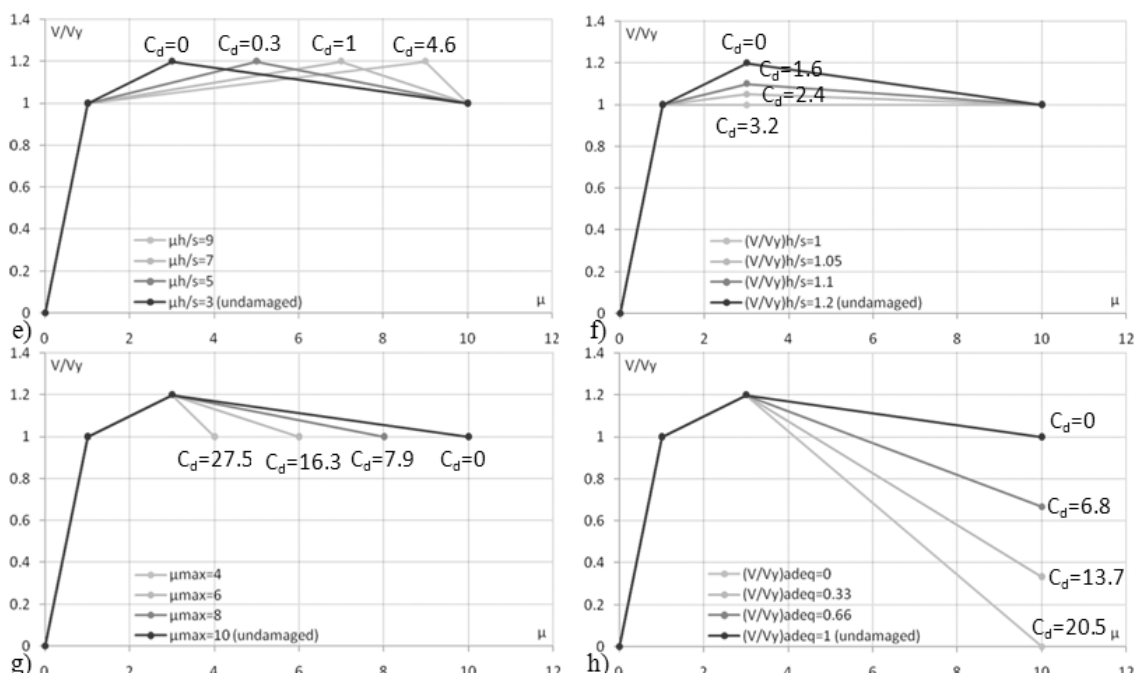

Slika 3. Pushover krive i koeficijenti oštećenja C_d određeni parametarskom analizom: a) inicijalni koeficijent duktilnosti μ_0 ; b) inicijalna relativna ukupna smičuća sila u osnovi objekta $(V/V_y)_0$; c) koeficijent duktilnosti na granici tečenja μ_y ; d) relativna ukupna smičuća sila u osnovi objekta na granici tečenja $(V/V_y)_y$; e) koeficijent duktilnosti za nivo ojačanja/omekšanja $\mu_{h/s}$; f) relativna ukupna smičuća sila u osnovi objekta za nivo ojačanja/omekšanja $(V/V_y)_{h/s}$; g) koeficijent maksimalno realizovane duktilnosti μ_{max} ; h) odgovarajuća relativna ukupna smičuća sila u osnovi objekta $(V/V_y)_{adeq}$

Figure 3. Pushover curves and damage coefficients C_d obtained by parametric analysis: a) initial coefficient of ductility μ_0 , b) initial relative total base shear force of the building $(V/V_y)_0$, c) coefficient of ductility at yield limit μ_y , d) relative total base shear force of the building at yield limit $(V/V_y)_y$, e) coefficient of ductility for the level of hardening/softening $\mu_{h/s}$, f) relative total base shear force of the building for the level of hardening/softening $(V/V_y)_{h/s}$, g) coefficient of the maximum realized ductility μ_{max} , h) adequate relative total base shear force of the building $(V/V_y)_{adeq}$

Visoke vrednosti koeficijenta duktilnosti za nivo ojačanja/omekšanja $\mu_{h/s} > 6$ uslovljavaju i veće oštećenje objekta (slika 3e), dok je pri nižim vrednostima $\mu_{h/s}$ koeficijent oštećenja C_d znatno niži. S druge strane, postepenim povećanjem relativne ukupne smičuće sile u osnovi objekta za nivo ojačanja/omekšanja $(V/V_y)_{h/s}$ i koeficijent oštećenja C_d postepeno se povećava, ali ne disproporcionalno, kao što je to slučaj sa $\mu_{h/s}$ (slika 3f). U odnosu na sve prethodno analizirane parametre, najosetljivijim su se pokazali koeficijent maksimalno realizovane duktilnosti μ_{max} i odgovarajuća relativna ukupna smičuća sila u osnovi objekta $(V/V_y)_{adeq}$. Na slici 3g i 3h prikazane su varijacije ovih parametara i proračunati koeficijenti oštećenja C_d .

High values of the coefficient of ductility for the level of hardening/softening $\mu_{h/s} > 6$ also lead to higher damage to the building (Figure 3e), while with lower $\mu_{h/s}$ values, the damage coefficient C_d is much lower. However, a gradual increase in the relative total base shear force of the building for the level of hardening/softening $(V/V_y)_{h/s}$ also leads to the gradual increase in the damage coefficient C_d , but this increase is not disproportional, as it is the case with $\mu_{h/s}$ (Figure 3f). The coefficient of maximum realized ductility μ_{max} and the adequate total relative base shear force of the building $(V/V_y)_{adeq}$ are proven the most sensitive among all analyzed parameters. Figures 3g and 3h show the variation of these parameters and calculated damage coefficients C_d .

4 NUMERIČKE ANALIZE I DISKUSIJA REZULTATA

4.1 Model zgrade

Verifikacija razvijenog scenarija povezanih nelinearnih analiza sprovedena je na primeru desetospratne zgrade okvirnog statičkog sistema. Na slici 4 prikazani su 3D model i osnova desetospratne zgrade. Prethodno je zgrada projektovana prema EN 1992 [8] i EN 1998 [9] propisima, uzimajući u obzir

4 NUMERICAL ANALYSIS AND DISCUSSION

4.1 The building model

Verification of the developed scenario of related non-linear analyses is performed on the example of a 10 storey buildings with a frame static system. The 3D model and layout of a 10 storey building are displayed in figure 4. Previously the building was designed in compliance with EN 1992 [8] and EN 1998 [9] codes,

koncept proračuna prema metodi programiranog ponašanja. Dimenzije zgrade u osnovi su 36x24m, dok su dimenzije jednog polja 6x6m. Visina jednog sprata je 3,3m, a ukupna visina zgrade je 33m. Zgrada je projektovana za beton klase čvrstoće C25/30. Od prizemlja do petog sprata, dimenzije spoljašnjih stubova su 50x60cm, a unutrašnjih 60x70cm, dok su od petog do desetog sprata dimenzije spoljašnjih stubova 40x50cm, a unutrašnjih 50x60cm. Od prizemlja do petog sprata, dimenzije greda su 35x60cm, a od petog do desetog sprata 30x60cm. Debljina ploče svih spratova iznosi 20cm.

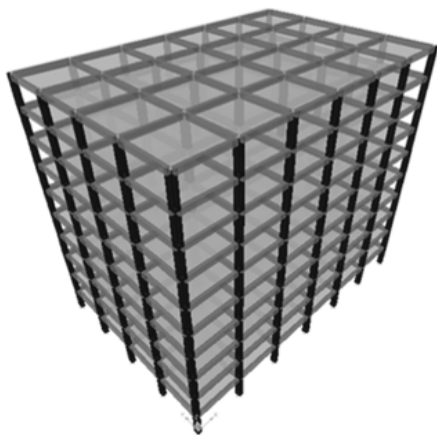

taking into consideration the calculation concept according to the *Capacity Design Method*. The floor plan dimensions of the building are 36x24m, while the dimensions of a bay are 6x6m. The total height of the building is 33m, but the height of one storey is 3.3m. The building is designed for concrete class C25/30. From the ground-floor to the fifth storey, the dimensions of the external columns are 50x60cm, and of the internal ones 60x70cm, while from the fifth storey to the tenth storey, dimensions of the external columns are 40x50cm, and of the interior ones 50x60cm. From the ground-floor to the fifth storey, the dimensions of the beams are 35x60cm, and from the fifth storey to the tenth storey they are 30x60cm. The thickness of slabs of all storeys is 20cm.

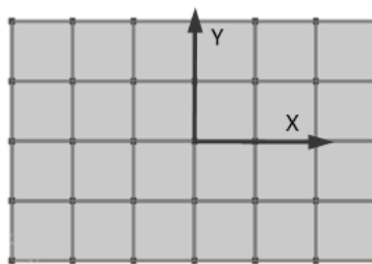

Slika 4. 3D model i osnova desetospratne zgrade
Figure 4. 3D model and layout of the 10-storey building

Opterećenje zgrade računato je kao stalno (sopstvena težina konstruktivnih elemenata zgrade i dodatno stalno opterećenje $g=3\text{kN/m}^2$), korisno (povremeno $p=3\text{kN/m}^2$) i seizmičko opterećenje. Zgrada je projektovana za povratni period referentnog seizmičkog dejstva od $T=475\text{g}$, projektno ubrzanje tla $a_g=0,3g$, tip tla C, klasu duktilnosti DCH i faktor ponašanja $q=5,85$. Zgrada je torziono neosetljiva, s obzirom na to što se centri krutosti poklapaju s centrima masa svih spratova i što se nalaze na jednoj vertikali. Međutim, pri proračunu seizmičkih uticaja dodatno je uzeta vrednost ekscentriciteta od 5% za oba ortogonalna pravca, tako da se za seizmičke kombinacije može smatrati da je zgrada torziono umereno osetljiva. Seizmičke kombinacije su proračunate za bidirekciono dejstvo zemljotresa. Broj svojstvenih oblika koji je uzet u obzir jeste 30, dok su pri proračunu statičkih uticaja uzeti u obzir i $P-\Delta$ efekti. U svim čvorovima ispunjen je kriterijum da je odnos sume momenata krajeva stubova i sume momenata krajeva greda veći od 1,3. Budući da se konstruktivni sistem zgrade formira od stubova i greda kao linijskih elemenata i ploča kao površinskih elemenata, ovakve zgrade pripadaju grupi neukrućenih i pomerljivih sistema. Za ove sisteme veoma je bitno da se ograniči relativno spratno pomeranje prema $d_r v \leq 0,01h$, gde je h visina sprata, v faktor redukcije kojim se uzima u obzir niži povratni period seizmičkog događaja i odnosi se na granično stanje upotrebljivosti, d_r proračunsko međuspratno relativno horizontalno pomeranje, izračunato kao razlika između osrednjenih horizontalnih pomeranja d_s na vrhu i na dnu

The building load is calculated as a permanent one (dead weight of the structural building elements and the additional permanent load $g=3\text{kN/m}^2$), useful (live load $p=3\text{kN/m}^2$) and seismic load. The building was designed for the return period of reference seismic action of $T=475\text{g}$, design ground acceleration $a_g=0.3g$, ground type C, ductility class DCH and behaviour factor $q=5.85$. The building is insensitive to torsion since the stiffness centres coincide with the centres of mass of all the storeys and they are located along one vertical. However, in calculation of seismic effects, and additional value of eccentricity of 5% is assumed for both orthogonal directions, so for the seismic combinations, it can be considered that the building is moderately sensitive in terms of torsion. Seismic combinations are calculated for the bidirectional action of the earthquake. The number of characteristic modes, which was taken in consideration, is 30, while in calculation of the static influences the $P-\Delta$ effects are taken in consideration as well. In all the nodes, the criterion that the ratio of the sum of the moments on the ends of the columns and the sum of the moments on the ends of the beams is higher than 1.3, is satisfied. Since structural system of the building is formed by columns and beams as linear elements, and slabs as surface elements, such buildings belong to the group of non-stiff and deformable systems. For these systems, it is very important to limit the relative inter-storey drift according to $d_r v \leq 0.01h$, where h is the height of the storey, v is reduction factor which takes into consideration the lower return period of the seismic event and refers to the limit state of serviceability, d_r

posmatranog sprata [9]. Na slici 5a prikazani su globalni driftovi DR 3D modela okvirne zgrade proračunati primenom LSA i SMA analiza, čije su maksimalne vrednosti manje od 0,2%, dok su na slici 5b prikazani međuspratni driftovi IDR 3D modela okvirne zgrade i granične vrednosti pomeranja prema prethodnom izrazu u funkciji međuspratnog drifta IDR_{EC8} za X i Y pravce. Maksimalne vrednosti međuspratnih driftova manje su od granične vrednosti međuspratnog drifta IDR_{EC8} za $v=0,5$.

design inter-storey relative horizontal drift, calculated as the difference between mean horizontal drifts d_s at the top and the bottom of the observed storey [9]. The global drifts DR of the 3D model of the frame building are presented in Figure 5a; they are calculated using LSA and SMA analyses whose maximum values are lower than 0.2%, while inter-storey drifts IDR of the 3D model of frame buildings and ultimate drift values according to the previous expression, in the functions of the inter-storey drift IDR_{EC8} for X and Y directions are presented in the Figure 5b. Maximum values of inter-storey drifts are lower than the limit value of the inter-storey drift IDR_{EC8} for $v=0.5$.

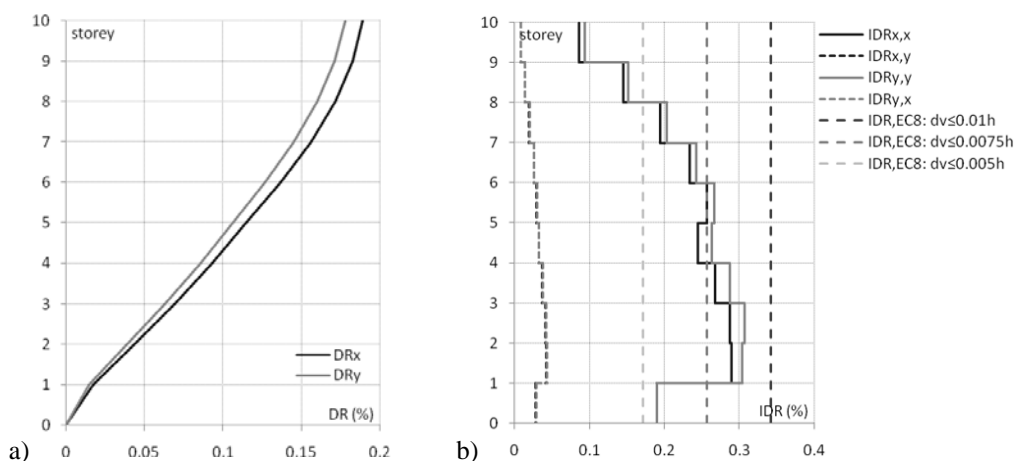

Slika 5. a) globalni driftovi DR ; b) međuspratni driftovi IDR 3D modela okvirne zgrade, određeni SMA analizom
Figure 5. a) global drifts DR , b) inter-storey drifts IDR of the 3D frame building model calculated using SMA analysis

4.2 Selekcija i skaliranje akcelorograma

Za potrebe istraživanja prikazanog u ovom radu, korišćeni su akcelorogrami prirodnih zemljotresa koji su se dogodili u prošlosti na teritoriji Srbije i Crne Gore. Akcelorogrami su preuzeti iz evropske baze jakih zemljotresa (ESD) [18] i tretirani su kao neskalirani, a naknadno su skalirani prema zahtevima koji su postavljeni u ovom istraživanju. Svi akcelorogrami su filtrirani eliptičnim pojasnopropusnim filterom, propuštajući frekvencije u intervalu $f=[0.25;25]$ Hz. Zatim je sprovedena korekcija bazne linije primenjujući linearnu funkciju. U tabeli 1 prikazano je deset selektovanih i preuzetih akcelorograma iz ESD baze zemljotresa, gde je M_w momentna magnituda, a PHA maksimalno horizontalno ubrzanje.

4.2 Selecting and scaling the accelerograms

For the purpose of the research presented in this paper accelerograms of natural earthquakes that occurred in the past on the territory of Serbia and Montenegro were used. The accelerograms were taken from the *European Strong-Motion Database* (ESD) [18] and they were treated as non-scaled; they were subsequently scaled according to the requirements set out in this research. All accelerograms were filtered using 8th order elliptical bandpass-filter, passing frequencies in the interval of $f=[0.25;25]$ Hz. This was followed by base line correction using linear function. Table 1 shows the ten accelerograms selected and downloaded from the ESD earthquake base, where M_w is the moment magnitude and PHA is maximum horizontal acceleration.

Tabela 1. Selektovani i preuzeti akcelorogrami iz ESD baze zemljotresa
Table 1. The selected and downloaded accelerograms from the ESD earthquake base

no.	year	earthquake	station	M_w	PHA (m/s ²)
1	1979	Montenegro	Petrovac - Hotel Oliva	5.4	0.484
2	1979	Montenegro	Debar - Skupština opštine	6.9	0.599
3	1979	Montenegro	Bar - Skupština opštine	5.8	0.813
4	1979	Montenegro	Petrovac - Hotel Rivijera	6.2	2.703
5	1979	Montenegro	Veliki Ston - Fabrika soli	6.9	2.624
6	1980	Kopaonik	Niš - Škola D. Jovanović	5.9	0.367
7	1980	Kopaonik	Priština - Zavod za urbanizam	5.9	0.293
8	1979	Montenegro (aftershock)	Kotor - Naselje Rakite	6.2	0.56
9	1979	Montenegro	Banja Luka - Borik 9	6.9	0.089
10	1979	Montenegro	Berane - Opština	6.9	0.159

Skaliranje akceleroograma sprovedeno je primenom metode najmanjih kvadrata (LSM), minimizirajući razliku između skaliranog spektra odgovora i projektnog spektra odgovora prema [10]:

$$|\Delta| = \int_{T_A}^{T_B} [F_s S_{a,us}(T) - S_{a,d}(T)]^2 dT, \quad (4)$$

gde je F_s faktor skaliranja, $S_{a,us}(T)$ spektralna akceleracija neskalinanog akceleroograma (akceleroogram prirodnog zemljotresa), $S_{a,d}(T)$ spektralna akceleracija projektnog (elastičnog) spektra odgovora prema propisima, T_A i T_B donja i gornja granična vrednost intervala perioda vibracija za koji se sprovodi skaliranje. Određivanje faktora skaliranja sprovodi se minimiziranjem razlike definisane u prethodnom izrazu:

$$\min|\Delta| \Rightarrow \frac{d|\Delta|}{dF_s} = 0 \Rightarrow F_s = \frac{\sum_{T_A}^{T_B} (S_{a,us}(T) S_{a,d}(T))}{\sum_{T_A}^{T_B} (S_{a,us}(T))^2}. \quad (5)$$

U ovom istraživanju korišćen je elastični spektar odgovora prema EN 1998 [9] propisu, u odnosu na koji se sprovodi skaliranje, za maksimalno ubrzanje tla $PGA=0,3g$. Preporuka EN 1998 [9] propisa je da se pri skaliranju razmatra interval perioda vibracija od $0,2T_1$ do $2T_1$, pri čemu je T_1 period vibracija za prvi svojstveni oblik. Dodatna kontrola ovog intervala perioda vibracija sprovedena je razmatrajući pri kojem poslednjem periodu vibracija zgrade se dobija da je zbir efektivnih modalnih masa za sve razmatrane svojstvene oblike vibracija veći od 90% od ukupne mase konstrukcije [6]. Donja granica kriterijuma $0,2T_1$ koji definiše EN 1998 može se pokazati, u određenim situacijama, kao problematična, ali se u ovom slučaju, naknadnom kontrolom, pokazala kao korektna. Nakon određivanja faktora skaliranja, za svaki akceleroogram pojedinačno (različiti faktori skaliranja), sprovedene su analize spektara odgovora, a zatim je određena srednja vrednost spektra odgovora $S_{a,ave}(T)$. Prema EN 1998 [9] nijedna vrednost osrednjenog elastičnog spektra odgovora izračunatog iz svih akceleroograma, a za interval od $0,2T_1$ do $2T_1$, ne sme da bude manja od 90% od odgovarajuće vrednosti elastičnog spektra odgovora. S obzirom na to što je određen broj vrednosti spektralnih akceleracija osrednjenog spektra odgovora $S_{a,ave}(T)$, proračunatog primenom LSM metode, manji od 90% od spektra odgovora prema EN 1998, naknadno je sprovedeno skaliranje osrednjenog spektra odgovora $S_{a,ave}(T)$. Na slici 6a prikazani su spektri odgovora originalnih neskalinanih akceleroograma selektovani i preuzeti iz ESD baze zemljotresa, dok je na slici 6b prikazan projektni elastični spektar odgovora prema EN 1998, 90% projektni elastični spektar odgovora prema EN 1998, osrednjen spektar odgovora skaliranih akceleroograma i naknadno skaliran osrednjen spektar odgovora skaliranih akceleroograma.

The accelerograms were scaled using the *Least Squares Method* (LSM) by minimizing the difference between the scaled response spectrum and the design response spectrum according to [10]:

where F_s is the scaling factor, $S_{a,us}(T)$ is the spectral acceleration of the unscaled accelerogram (accelerogram of natural earthquake), $S_{a,d}(T)$ is the spectral acceleration of the design (elastic) response spectrum according to the regulations, T_A and T_B are the lower and upper limits of vibration period interval for which the scaling was conducted. The scaling factor is determined by minimizing the difference defined in the previous expression:

The elastic response spectrum according to EN 1998 code [9] was used in this research based on which the scaling was carried out for maximum ground acceleration of $PGA=0.3g$. As recommended in [9], the scaling should be conducted by considering the vibration period interval from $0.2T_1$ to $2T_1$, where T_1 is the vibration period for the first eigenform. The vibration period interval was additionally controlled by identifying the building's last period of vibration for which the sum of effective modal masses for all considered eigenforms of vibration is higher than 90% of the total mass of the structure [6]. In certain circumstances, the lower $0.2T_1$ limit defined by the EN 1998 code can be problematic, but in this case, the additional control has proved it correct. After determining the scaling factor for each accelerogram individually (different scaling factors) the response spectra analyses were carried out, which was followed by the identification of the average response spectrum value $S_{a,ave}(T)$. According to the EN 1998 code [9], no value of an average elastic response spectrum calculated from all accelerograms for the $0.2T_1$ to $2T_1$ interval, should not be lower than 90% of the corresponding value of elastic response spectrum. Given that a number of values of spectral acceleration of the average response spectrum $S_{a,ave}(T)$, as calculated using the LSM method, is lower than 90% of the response spectrum provided in the EN 1998 code, the average response spectrum $S_{a,ave}(T)$ was subsequently scaled. Figure 6a shows the response spectra of the original unscaled accelerograms, selected and downloaded from the ESD earthquake base. Figure 6b shows the design elastic response spectrum according to the EN 1998 code, 90% of the design elastic response spectrum according to the EN 1998 code, the average response spectrum of the scaled accelerograms and their subsequently scaled averaged response spectrum.

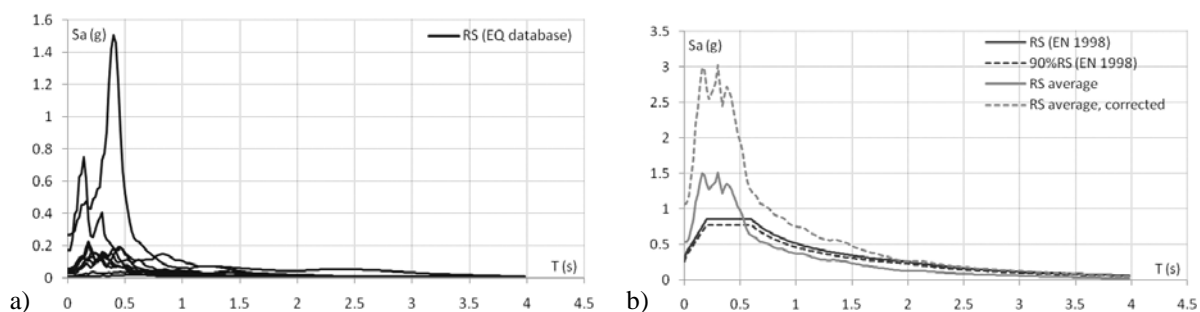

Slika 6. a) spektri odgovora originalnih neskaliiranih akcelorograma selektovani i preuzeti iz ESD baze zemljotresa; b) projektni elastični spektar odgovora prema EN 1998, 90% projektni elastični spektar odgovora prema EN 1998, osrednjen spektar odgovora skaliranih akcelorograma i naknadno skaliran osrednjen spektar odgovora skaliranih akcelorograma

Figure 6. a) response spectra of the original unscaled accelerograms selected and downloaded from the ESD earthquake base, b) the design elastic response spectrum according to the EN 1998 code, 90% of the design elastic response spectrum according to the EN 1998 code, the averaged response spectrum of the scaled accelerograms and their subsequently scaled averaged response spectrum

4.3 Scenarija oštećenja zgrade

Scenario kolapsa stubova sproveden je eliminacijom pojedinih stubova u prizemlju desetospratne zgrade. Na slici 7 prikazano je devet scenarija kolapsnih stanja stubova prizemlja, pri čemu su moguće opcije kolapsa u okviru pojedinačnih scenarija:

- scenarija u kojima su prikazana kolapsna stanja samo ivičnih stubova odgovaraju mogućem oštećenju ovih stubova usled terorističkog akta aktiviranjem eksploziva u vozilu postavljenog u neposrednoj blizini zgrade;
- scenarija u kojima su prikazana kolapsna stanja samo unutrašnjih stubova odgovaraju mogućem oštećenju ovih stubova usled terorističkog akta aktiviranjem eksploziva postavljenog unutar zgrade;
- scenarija u kojima su prikazana kolapsna stanja i unutrašnjih i spoljašnjih stubova odgovaraju mogućem oštećenju ovih stubova usled dejstva snažnih zemljotresa.

4.3 Damage scenarios for the building

The scenario of column collapse was conducted by elimination of individual columns of the ground-floor of a 10-storey building. Nine scenarios of collapse states of ground-floor columns (or sudden removal corner, edge and internal columns) are presented in Figure 7 with the following possible options:

- the scenarios displaying collapse states of outer columns which correspond to the possible damage of columns due to the terrorist action comprising detonation of explosive in a vehicle parked in the immediate vicinity of the building,
- the scenarios displaying collapse states of inner columns which correspond to the potential damage of columns due to the terrorist action comprising detonation of explosive planted inside the building,
- the scenarios displaying collapse states of both interior and exterior columns which correspond to the possible damage of columns due to intensive earthquakes.

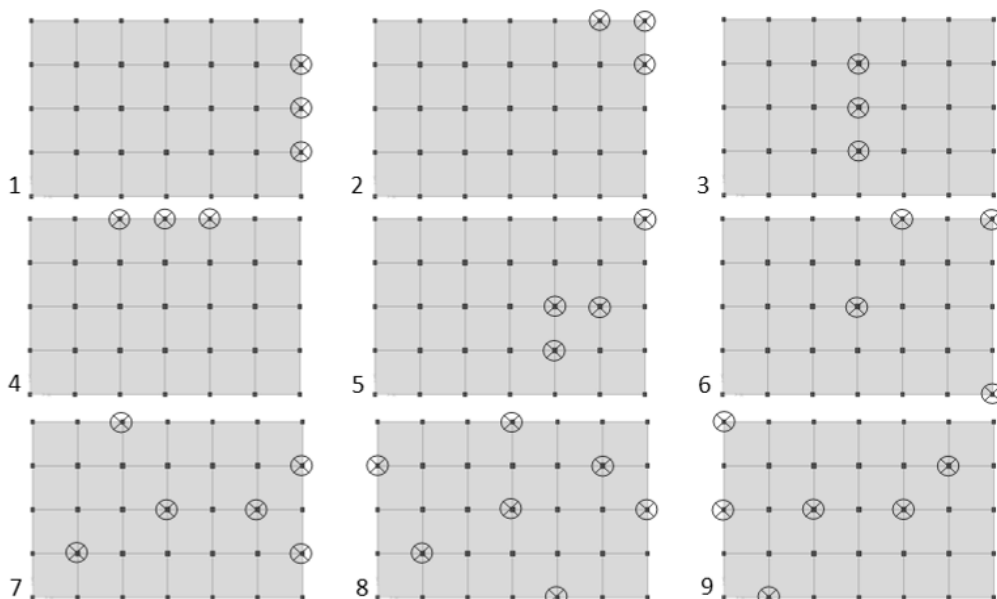

Slika 7. Scenarija oštećenja zgrade (kolaps stubova u prizemlju)
Figure 7. Scenarios of building damage (collapse of ground level columns)

4.4 Postprocesiranje rezultata numeričkih analiza: NSPA pushover krive

Razvoj materijalne nelinearnosti se sprovodi preko plastičnih zglobova, pri čemu je kod greda omogućena plastifikacija momentima savijanja, dok je kod stubova omogućena plastifikacija interakcijom momenata savijanja i normalnih sila. Posebno su razmatrana nelinearna ponašanja zgrada za X pravac, a posebno za Y pravac. Za X pravac sproveden je monitoring pomeranja najvišeg čvora zgrade u centru mase za stepen slobode u X pravcu, dok je za Y pravac sproveden monitoring pomeranja najvišeg čvora zgrade u centru mase za stepen slobode u Y pravcu. Prilikom sprovođenja NSPA analiza, za svaki pravac uzeto je u obzir bidirekciono seizmičko dejstvo primenom pravila $1EQ_X+0,3EQ_Y$, odnosno $1EQ_Y+0,3EQ_X$. Na slici 8 prikazane su NSPA pushover krive za sprovedene NSPA analize neoštećene zgrade i devet predefinisanih scenarija.

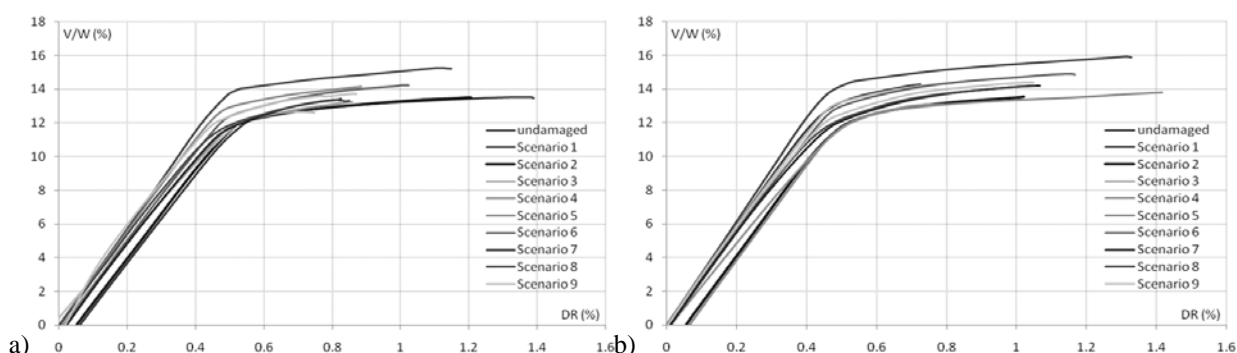

Slika 8. NSPA pushover krive za predefinisana scenarija: a) monitoring pomeranja za stepen slobode u X pravcu, b) monitoring pomeranja za stepen slobode u Y pravcu

Figure 8. NSPA pushover curves for the pre-defined scenarios: a) monitoring displacement for the degree of freedom in the X direction, b) monitoring displacement for the degree of freedom in the Y direction

Razmatrajući nosivost u nelinearnom domenu, kod svih NSPA pushover krivih može se konstatovati da je ona najveća kod neoštećene zgrade, što se i moglo očekivati. Međutim, iz aspekta realizovanih nelinearnih pomeranja, maksimalna pomeranja dobijena su u slučaju prvog scenarija za X pravac i četvrtog scenarija za Y pravac. Ovako dobijeni rezultati govore o nivou povredljivosti zgrade u X pravcu kada su oštećeni samo spoljašnji stubovi. Razmatrajući iniciranje krutosti u linearnom domenu, može se konstatovati da ne polaze sve NSPA pushover krive od nulte vrednosti. Ovo je posledica primene povezanih nelinearnih analiza kojim se uzima u obzir da su prvo nastupila kolapsna stanja u stubovima, pa je zatim sprovedena NSPA analiza. Prilikom ovakvih scenarija, nivo inicijalnog drifta najčešće je pomeren ka pozitivnoj vrednosti. U određenim slučajevima, nivoi maksimalno realizovanih pomeranja manji su od maksimalno realizovanih pomeranja koja su dobijena kod neoštećene zgrade. U ovim situacijama, kolaps zgrada nastupa ranije, pa što je nivo maksimalno realizovanog pomeranja manji, tim pre i nastupa kolapsno stanje zgrade.

4.4 Post-processing the results of numerical analyses: NSPA pushover curves

Material non-linearity is developed through plastic hinges, wherein beams are allowed to plastify under the impact of bending moments, while columns are allowed to plastify under the interaction of the bending moment and normal force. The non-linear behaviour of the buildings for the X direction was considered separately from that considered for the Y direction. In the case of the X direction, the displacement of the highest node of the building in the centre of mass for the degree of freedom (DOF) in the X direction was monitored, while in the case of the Y direction the displacement of the highest node of the building in the centre of mass for the degree of freedom in the Y direction was monitored. In the course of performing the NSPA analyses, bidirectional seismic action was assumed for each direction using the rule $1EQ_X+0.3EQ_Y$, i.e. $1EQ_Y+0.3EQ_X$. Figure 8 shows NSPA pushover curves for the pre-defined scenarios and undamaged building.

By considering the bearing capacity in the non-linear domain, for all NSPA pushover curves, it can be concluded that it is the highest for the undamaged building, which was to be expected. However, from the aspect of realized non-linear displacements, maximum displacements were obtained in the case of the first scenario for the X direction and the fourth scenario for the Y direction. The results obtained in this way describe the vulnerability level of the building in the case when only outer columns are damaged. Considering initiation of stiffness in the linear domain, it can be stated that not all the NSPA pushover curves start from the zero. This is the result of application of related non-linear analysis, which assumes that NSPA analysis was conducted after the collapse of the columns. For such scenarios, the level of initial drift is most frequently shifted towards the positive value. In certain cases, the levels of maximum realized drifts are lower than the maximum realized drifts obtained for undamaged buildings. In such situations, the collapse of the buildings sets sooner, so the lower the level of maximum realized drift, the sooner the collapse state of the building.

4.5 Postprocesiranje rezultata numeričkih analiza: nivo ciljnog pomeranja

U drugom delu istraživanja sprovedene su analize nivoa ciljnog pomeranja po metodi spektra kapaciteta (CSM) prema ATC 40 [3] propisu za naknadno skaliran osrednjen spektar odgovora skaliranih akcelerograma. U tabeli 2 prikazani su proračunati parametri nivoa ciljnog pomeranja prema CSM metodi za neoštećenu zgradu i moguće scenarije, posebno za X pravac, a posebno za Y pravac. Pored parametara, kao što su nivo ciljnog pomeranja D_t , ukupna smičuća sila u osnovi zgrade za nivo ciljnog pomeranja V_t , efektivan period vibracija za nivo ciljnog pomeranja $T_{eff,t}$ i koeficijent efektivnog prigušenja za nivo ciljnog pomeranja $\xi_{eff,t}$, prikazana su i procentualna odstupanja po scenarijama u odnosu na model neoštećene zgrade. Nivo ciljnog pomeranja nije identičan za neoštećenu zgradu i sva predefinisana scenarija, s obzirom na to što razmatranje i nije sprovedeno za isti nivo ciljnog pomeranja, već za isti nivo seizmičkog zahteva. Efektivan period vibracija za nivo ciljnog pomeranja $\xi_{eff,t}$ odgovara sekantnom periodu vibracija u kapacitivnom domenu, odnosno u formatu spektralno pomeranje-spektralno ubrzanje (ADRS). Ovaj period vibracije znatno je duži od elastičnog perioda vibracija zgrade, budući da se uzima u obzir razvoj elastoplastičnih deformacija u određenim poprečnim presecima. Za X pravac su najproblematičniji treći i sedmi scenario, jer se za nivo seizmičkog zahteva nije moglo realizovati ciljno pomeranje (N/A), odnosno jer je kapacitet nelinearnih deformacija konstrukcije isuviše mali. Za Y pravac su najproblematičniji prvi, treći i peti scenario prilikom kojih se takođe nije moglo realizovati ciljno pomeranje. U slučaju svih scenarija kolapsa stubova vrednosti efektivnog perioda vibracija za nivo ciljnog pomeranja $T_{eff,t}$ se povećavaju, u odnosu na $T_{eff,t}$ kod neoštećene zgrade, dok se ukupna smičuća sila u osnovi zgrade za nivo ciljnog pomeranja V_t po svim scenarijima smanjuje, a nivo ciljnog pomeranja D_t povećava.

4.5 Post-processing the results of numerical analysis: target displacement

In the second part of the research, target displacement analyses were conducted according to the CSM (*Capacity Spectrum Method*) from the ATC 40 [3] codes, assuming the subsequently scaled averaged response spectrum of scaled accelerograms. The calculated target displacement parameters according to the CSM for the undamaged building and possible scenarios, separately for the X direction and separately for the Y direction are presented in Table 2. Departures in percents per scenario, in comparison with the model of the undamaged building are presented apart from the parameters, such as: the level of target displacement D_t , the total base shear force for the target displacement level V_t , effective period of vibrations for the target displacement level $T_{eff,t}$ and coefficient of effective damping for the target displacement level $\xi_{eff,t}$. The level of target displacement is not identical for the undamaged building and all the pre-defined scenarios, as the consideration was not conducted for the same level of target displacement, but the same level of seismic demand. The effective period of vibrations for the target displacement level $\xi_{eff,t}$ corresponds to the second period of vibrations in terms of capacity, i.e. in the ADRS (acceleration-displacement response spectra) format. This period of vibrations is considerably higher than the elastic period of building vibration, since the development of elastic-plastic deformations in certain cross-sections is taken into account. The most problematic scenarios for the X direction are the third and seventh, since for the seismic demand the target displacement could not be realized (N/A), i.e. capacity of non-linear deformations of the structure is too small. The most problematic scenarios for the Y direction are the first, third and fifth scenarios, where target displacement could not be realized, either. For all the scenarios of the column collapse, the values of effective period of vibrations for the target displacement level $T_{eff,t}$ increase, in comparison to $T_{eff,t}$ of the undamaged building. On the other hand, the total base shear force of the building for the target displacement level V_t decreases in all the scenarios, while the level of the target displacement D_t increases.

Tabela 2. Proračunati parametri nivoa ciljnog pomeranja prema CSM metodi za naknadno skaliran osrednjen spektar odgovora skaliranih akcelerograma

Table 2. The calculated parameters of the target displacements according to the CSM method for the subsequently scaled averaged response spectrum of scaled accelerograms

monitoring X DOF									
scenario	D_t (cm)		V_t (kN)		$T_{eff,t}$ (s)		$\xi_{eff,t}$ (%)		
undamaged	26.8		14477.8		2.80		20.8		
1	28.9	+7.8%	12828.3	-11.4%	2.94	+5.0%	20.8	0%	
2	28.5	+6.3%	12847.9	-11.3%	2.97	+6.1%	21.0	+1.0%	
3	N/A	-	N/A	-	N/A	-	N/A	-	
4	27.0	+0.8%	13794.8	-4.7%	2.92	+4.3%	21.3	+2.4%	
5	27.9	+4.1%	12976.1	-10.4%	3.02	+7.9%	20.2	-2.9%	
6	27.9	+4.1%	13693.6	-5.4%	2.92	+4.3%	21.0	+1.0%	
7	N/A	-	N/A	-	N/A	-	N/A	-	
8	27.1	+1.1%	13134.7	-9.3%	2.99	+6.8%	21.4	+2.9%	
9	26.3	-1.9%	13367.5	-7.7%	2.94	+5.0%	21.7	+4.3%	

monitoring Y DOF								
scenario	D_t (cm)		V_t (kN)		$T_{eff,t}$ (s)		$\xi_{eff,t}$ (%)	
undamaged	26.9		14940.1		2.76		20.8	
1	N/A	-	N/A	-	N/A	-	N/A	-
2	29.0	+7.8%	13086.2	-12.4%	2.92	+5.8%	20.4	-1.9%
3	N/A	-	N/A	-	N/A	-	N/A	-
4	29.2	+8.6%	12989.4	-13.1%	2.91	+5.4%	21.0	+1.0%
5	N/A	-	N/A	-	N/A	-	N/A	-
6	28.0	+4.1%	14210.5	-4.9%	2.88	+4.4%	21.1	+1.4%
7	28.1	+4.5%	13622.9	-8.8%	2.97	+7.6%	21.2	+1.9%
8	27.7	+2.9%	13584.8	-9.1%	2.96	+7.3%	20.7	-0.5%
9	27.5	+2.2%	13816.0	-7.5%	2.90	+5.1%	20.7	-0.5%

Nakon određivanja nivoa ciljnog pomeranja po svim scenarijima, proračunati su globalni DR i međuspratni driftovi IDR , tako što su naknadno procesirane NSPA analize sprovodeći monitoring pomeranja za odgovarajući stepen slobode i odgovarajući pravac do nivoa ciljnog pomeranja svakog scenarija pojedinačno. Zatim su izdvajane vrednosti pomeranja po čvorovima spratova za odgovarajući pravac i određivane maksimalne vrednosti ovih pomeranja po spratovima. Globalni driftovi DR za nivo ciljnog pomeranja određeni su prema:

$$DR_{t,i} = \frac{|D_{t,i,j,k,max}|}{H_i}, \quad (6)$$

gde je $DR_{t,i}$ globalni drift pri nivou ciljnog pomeranja i -tog sprata, $D_{t,i,j,k,max}$ maksimalno pomeranje pri nivou ciljnog pomeranja j -tog čvora i -tog sprata k -tog stepena slobode, H_i visina i -tog sprata od osnove. Međuspratni driftovi IDR za nivo ciljnog pomeranja određeni su prema:

$$IDR_{t,i} = \frac{|D_{t,i+1,j,k,max}| - |D_{t,i,j,k,max}|}{H_{i+1} - H_i}, \quad (7)$$

gde je $IDR_{t,i}$ međuspratni drift pri nivou ciljnog pomeranja i -tog sprata. Na slici 9 prikazani su globalni driftovi DR za X i Y pravac pri nivou ciljnog pomeranja 3D modela okvirne zgrade, određeni za isti nivo seizmičkog zahteva. Maksimalne vrednosti globalnog drifta za X i Y pravac neoštećene zgrade najniže su u odnosu na sva razmatrana scenarija. Takođe, i ostale vrednosti globalnih driftova neoštećene zgrade su manje, u odnosu na sva razmatrana scenarija, izuzev manjeg odstupanja od drugog do šestog sprata petog scenarija X pravca. U slučaju trećeg i sedmog scenarija X pravca i prvog, trećeg i petog scenarija Y pravca, nisu realizovane vrednosti nivoa ciljnog pomeranja, tako da su i odgovarajuće vrednosti globalnih driftova izjednačene sa nulom.

After determining the levels of target displacement for all scenarios, the global DR and the inter-storey drifts IDR were calculated by post-processing the NSPA analyses based on monitoring displacements for the corresponding degree of freedom and corresponding direction before the level of target displacement for each individual scenario. Then the values of displacement at storey nodes for the corresponding direction were singled out and the maximum values of these displacements at stories identified. Global drifts DR for level of target displacement are determined by:

where $DR_{t,i}$ is the global drift at the level of target displacement of the i -th storey, $D_{t,i,j,k,max}$ is the maximum displacement at the level of target displacement of j -th node of the i -th storey of the k -th degree of freedom, H_i is the height of the i -th storey from the basement. Inter-storey drifts IDR for the level of target displacement are determined by:

where $IDR_{t,i}$ is inter-storey drift at the level of target displacement of the i -th storey. Figure 9 shows the global drifts DR for the X and Y directions at the level of target displacement of the 3D frame building model for the same level of seismic demand. Maximum values of the global drift for the X and Y directions of the undamaged building are the lowest of all scenarios taken into consideration. Other values of global drifts of undamaged building are also lower than in all other scenarios considered, except for a slight deviation between the second to the sixth storey of the fifth scenario of X direction. In the cases of the third and seventh scenario of X direction and the first, third and fifth scenarios of Y direction, values at the level of target displacement were unrealized, so that the corresponding values of global drifts are equal to zero.

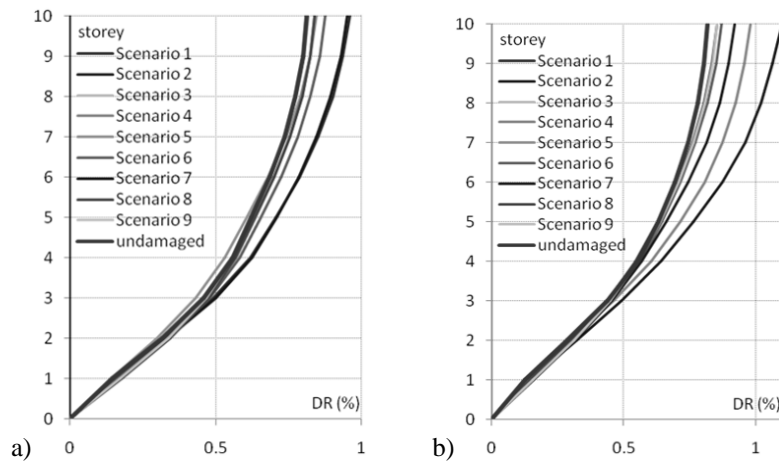

Slika 9. Globalni driftovi DR pri nivou ciljnog pomeranja 3D modela okvirne zgrade, određeni za isti nivo seizmičkog zahteva: a) X pravac; b) Y pravac

Figure 9. Global drifts DR at the level of target displacement of the 3D frame building model, obtained for the same level of seismic demand: a) X direction, b) Y direction

Na slici 10 prikazani su međuspratni driftovi *IDR* za X i Y pravac pri nivou ciljnog pomeranja 3D modela okvirne zgrade, određeni za isti nivo seizmičkog zahteva. Međuspratni driftovi neoštećene zgrade su minimalni od četvrtog do desetog sprata, dok su kod nižih spratova, samo u određenim scenarijima, realizovane još niže vrednosti međuspratnih driftova. Međutim, u svim scenarijima ukupna smičuća sila u osnovi zgrade za nivo ciljnog pomeranja jeste niža, a čime je smanjena nosivost zgrade u nelinearnom domenu, nego što je to slučaj kod neoštećene zgrade. Ovo se može najbolje sagledati pomoću tabele 2, gde su prikazana procentualna odstupanja ukupne smičuće sile u osnovi zgrade. Na primer, u slučaju scenarija 1, gde su eliminisana samo tri ivična stuba u prizemlju zgrade, ukupna smičuća sila u osnovi zgrade je redukovana i više od 11%.

Figure 10 shows the inter-storey drifts *IDR* for X and Y directions at the level of target displacement of the 3D frame building model, obtained for the same level of seismic demand. Inter-storey drifts of the undamaged building are minimal between the fourth to the tenth storey, while in lower stories only in certain scenarios were realized even lower values of inter-storey drift. However, in all scenarios, for the level of target displacement, the total base shear force of the building is lower than in the undamaged building, thus reducing its bearing capacity in the non-linear domain. This can be best seen in table 2, where the percentages of deviations of the total base shear force of the building are shown. For example, in the case of scenario 1, where only three bounding columns on the ground-floor were eliminated, the total base shear force of the building is reduced even by more than 11%.

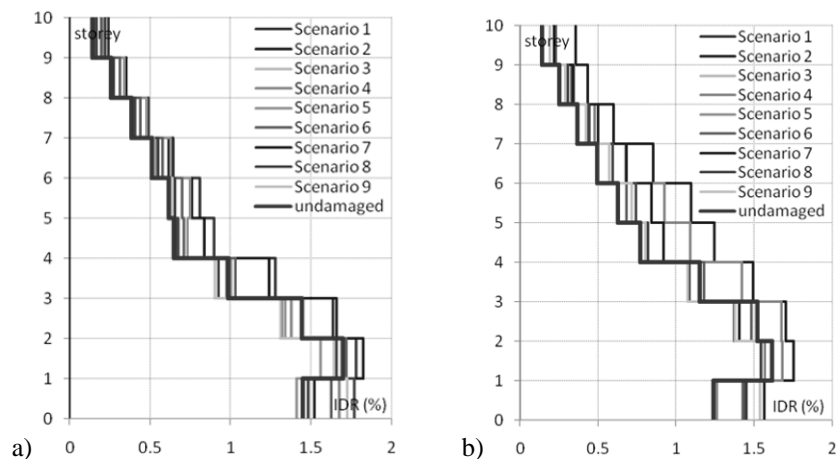

Slika 10. Međuspratni driftovi IDR pri nivou ciljnog pomeranja 3D modela okvirne zgrade, određeni za isti nivo seizmičkog zahteva: a) X pravac; b) Y pravac

Figure 10. Inter-storey drifts IDR at the level of target displacement of the 3D frame building model obtained for the same level of seismic demand: a) X direction, b) Y direction

4.6 Postprocesiranje rezultata numeričkih analiza: maksimalno realizovan nivo pomeranja

U trećem delu istraživanja sprovedene su analize maksimalno realizovanog nivoa pomeranja (kolapsno stanje), pri čemu su u tabeli 3 prikazani proračunati parametri za neoštećenu zgradu i moguće scenarije, posebno za X pravac, a posebno za Y pravac. Pored parametara, kao što su maksimalno realizovan nivo pomeranja D_{max} , ukupna smičuća sila u osnovi zgrade za maksimalno realizovan nivo pomeranja V_{max} , efektivan period vibracija za maksimalno realizovan nivo pomeranja $T_{eff,max}$ i koeficijent efektivnog prigušenja za maksimalno realizovan nivo pomeranja $\xi_{eff,max}$, prikazana su procentualna odstupanja po scenarijama u odnosu na model neoštećene zgrade. U ovom slučaju, procentualna odstupanja $T_{eff,max}$ i $\xi_{eff,max}$ nisu jednoznačna, već su i pozitivna i negativna, s obzirom na to što se dostižu maksimalna pomeranja po scenarijima, koja su i veća i manja od maksimalnih pomeranja neoštećene zgrade. Ukupna smičuća sila u osnovi zgrade za maksimalno realizovan nivo pomeranja V_{max} manja je prilikom svih scenarija, u odnosu na V_{max} neoštećene zgrade. Slična situacija je i kod maksimalno realizovanog nivoa pomeranja D_{max} , osim za prvi i drugi scenario X pravca i četvrti scenario Y pravca.

4.6 Post-processing the results of numerical analyses: the maximum realized level of displacement

Global DR and inter-storey drifts IDR for the maximum realized level of displacement (collapse state) are considered in the third part of the paper. The calculated parameters of the maximum realized displacement for the undamaged building and possible scenarios, separately for the X direction and separately for the Y direction are presented in table 3. Departures in percents per scenario, in comparison with the model of the undamaged building are presented apart from the parameters such as: maximum realized displacement D_{max} , total base shear force for the maximum realized displacement V_{max} , effective period of vibrations for the maximum realized displacement $T_{eff,max}$ and coefficient of effective damping for the maximum realized displacement $\xi_{eff,max}$. In this case the percentages of deviations of $T_{eff,max}$ and $\xi_{eff,max}$ are not uniform (unequivocal), but they are both positive and negative since the maximum displacements are reached in the scenarios, which are both higher and lower than the maximum displacements of the undamaged building. The total base shear force for the maximum realized displacement V_{max} is lower in all the scenarios in comparison with the V_{max} of the undamaged building. The situation is similar for the maximum realized level of displacement D_{max} , except for the first and second scenario of the X directions and fourth scenario of the Y direction.

Tabela 3. Proračunati parametri maksimalno realizovanog nivoa pomeranja (kolapsno stanje)
Table 3. Calculated parameters for the maximum realized displacement (collapse state)

monitoring X DOF								
scenario	D_{max} (cm)		V_{max} (kN)		$T_{eff,max}$ (s)		$\xi_{eff,max}$ (%)	
undamaged	37.9		14970.3		3.29		24.6	
1	45.9	+21.1%	13275.6	-11.3%	3.67	+11.6%	25.4	+3.3%
2	39.2	+3.4%	13928.3	-6.9%	3.02	-8.2%	22.4	-8.9%
3	24.7	-34.8%	12417.1	-17.1%	2.84	-13.7%	19.2	-21.9%
4	29.9	-21.1%	13273.8	-11.3%	3.48	+5.8%	24.6	0%
5	28.3	-25.3%	13011.5	-13.1%	3.05	-7.3%	20.6	-16.3%
6	33.8	-10.8%	13990.0	-6.5%	3.20	-2.7%	23.6	-4.1%
7	27.2	-28.2%	13206.4	-11.8%	2.95	-10.3%	21.1	-14.2%
8	28.1	-25.9%	13122.8	-12.3%	3.06	-7.0%	22.3	-9.3%
9	28.7	-24.3%	13491.5	-9.9%	3.07	-6.7%	22.9	-6.9%
monitoring Y DOF								
scenario	D_{max} (cm)		V_{max} (kN)		$T_{eff,max}$ (s)		$\xi_{eff,max}$ (%)	
undamaged	43.8		15634.8		3.41		24.9	
1	23.9	-45.4%	14040.0	-10.2%	2.71	-20.5%	18.3	-26.5%
2	33.7	-23.1%	13303.7	-14.9%	3.14	-7.9%	22.9	-8.0%
3	27.0	-38.3%	14115.8	-9.7%	2.89	-15.2%	20.7	-16.9%
4	46.7	+6.6%	13564.0	-13.2%	3.61	+5.9%	25.1	+0.8%
5	26.1	-40.4%	12875.6	-17.6%	2.88	-15.5%	18.5	-25.7%
6	38.5	-12.1%	14631.9	-6.4%	3.33	-2.4%	24.5	-1.6%
7	35.2	-19.6%	13976.1	-10.6%	3.29	-3.5%	23.9	-4.0%
8	34.7	-20.8%	13949.0	-10.8%	3.28	-3.8%	23.8	-4.4%
9	34.6	-21.0%	14164.9	-9.4%	3.22	-5.6%	23.7	-4.8%

Globalni driftovi DR za maksimalno realizovan nivo pomeranja (kolapsno stanje) određeni su prema:

Global drifts DR for maximum realized displacements (collapse state) are determined by:

$$DR_{max,i} = \frac{|D_{max,i,j,k,max}|}{H_i}, \quad (8)$$

gde je $DR_{max,i}$ globalni drift za maksimalno realizovan nivo pomeranja i -tog sprata, $D_{max,i,j,k,max}$ maksimalno pomeranje j -tog čvora za maksimalno realizovan nivo pomeranja i -tog sprata k -tog stepena slobode. Međuspratni driftovi IDR za maksimalno realizovan nivo pomeranja (kolapsno stanje) određeni su prema:

$$IDR_{max,i} = \frac{|D_{max,i+1,j,k,max}| - |D_{max,i,j,k,max}|}{H_{i+1} - H_i}, \quad (9)$$

gde je $IDR_{max,i}$ međuspratni drift za maksimalno realizovan nivo pomeranja i -tog sprata. Na slici 11 prikazani su globalni driftovi DR za X i Y pravac pri maksimalno realizovanom nivou pomeranja 3D modela okvirne zgrade. Razmatrajući globalne driftove DR može se konstatovati da su veći u slučaju prvog i drugog scenarija X pravca i četvrtog scenarija Y pravca, u odnosu na globalne driftove neoštećene zgrade. Svi ostali globalni driftovi su manji. To jasno ukazuje na to da se kolapsna stanja razvijaju mnogo ranije, nego što je to slučaj kod neoštećene zgrade, osim u slučaju prvog i drugog scenarija X pravca i četvrtog scenarija Y pravca, gde je vrednost duktilnosti povećana, ali je zato znatno smanjena nosivost kompletne zgrade u nelinearnom domenu.

where $DR_{max,i}$ is the global drift for the maximum realized level of displacement of the i -th storey, $D_{max,i,j,k,max}$ is maximum displacement of the j -th node for maximum realized level of displacement of the j -th storey of the k -th degree of freedom. Inter-storey drifts IDR for maximum realized displacement (collapse state) are determined by:

where $IDR_{max,i}$ is inter-storey drift for maximum realized level of displacement of the i -th storey. Figure 11 shows global drifts DR for X and Y directions at maximum displacement realized for 3D frame building model. When considering global drifts DR , it can be concluded that they are higher in cases of the first and second scenarios in the X direction and the fourth scenario in the Y direction, compared to the global drifts of undamaged building. All other global drifts are smaller. This clearly indicates that collapse states develop much earlier than in undamaged building, except in cases of the first and second scenario in the X direction and the fourth scenario in the Y direction, where the value of ductility is increased, but the bearing capacity of the entire building in the non-linear domain significantly reduced.

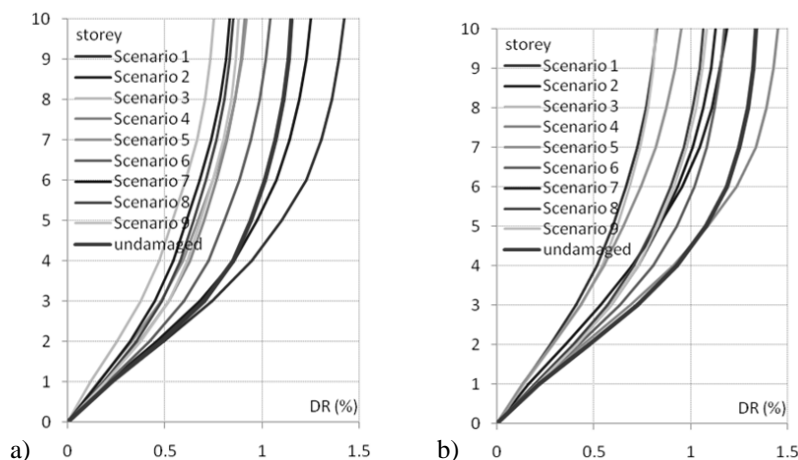

Slika 11. Globalni driftovi DR za maksimalno realizovan nivo pomeranja (kolapsno stanje) 3D modela okvirne zgrade: a) X pravac; b) Y pravac
Figure 11. Global drifts DR for the maximum realized displacement (collapse state) of the 3D frame building model: a) X direction, b) Y direction

Na slici 12 prikazani su međuspratni driftovi IDR za X i Y pravac za maksimalno realizovan nivo pomeranja 3D modela okvirne zgrade. Međuspratni driftovi IDR takođe ukazuju na veće vrednosti od prizemlja do šestog sprata u slučaju prvog i drugog scenarija X pravca i četvrtog scenarija Y pravca. Međutim, svi međuspratni driftovi iznad šestog sprata su gotovo veći od međuspratnih driftova neoštećene zgrade. To jasno ukazuje na činjenicu da se prilikom svih scenarija pri kolapsnim

Figure 12 shows the inter-storey drifts IDR in X and Y directions for the maximum realized displacements for the 3D frame building model. Inter-storey drifts IDR also indicate higher values between the ground and the sixth storey in the first and second scenario in the X direction and the fourth scenario in the Y direction. However, all inter-storey drifts above the sixth storey are almost bigger than those in the undamaged building. This clearly points to the fact that in all collapse-state

stanjima razvijaju veće vrednosti međuspratnih driftova kod viših spratova. Od prizemlja do šestog sprata, međuspratni driftovi su manji u slučaju svih scenarija, osim prilikom prvog i drugog scenarija X pravca i četvrtog scenarija Y pravca, mada se i oni smanjuju kod prizemlja i prvog sprata. Niže vrednosti međuspratnih driftova ukazuju na manji nivo povredljivosti zidova ispunje zgrade. Međutim, ove vrednosti međuspratnih driftova treba razmatrati u korelaciji s realizovanim globalnim driftovima zgrade. Kao što je već utvrđeno, svi globalni driftovi niži su od globalnih driftova neoštećene zgrade, osim prilikom prvog i drugog scenarija X pravca i četvrtog scenarija Y pravca, tako da veće vrednosti ovih međuspratnih driftova nije ni moguće realizovati, jer nastupa rano kolapsno stanje.

scenarios, higher inter-storey drifts occur at higher stories. Between the ground and the sixth storey, inter-storey drifts are lower in all scenarios, except for the first and second scenario in the X direction and the fourth scenario in the Y direction, although they also decrease at the ground and first storey. Lower values of inter-storey drifts indicate lower levels of vulnerability of the building's infill walls. However, these values of inter-storey drifts should be considered in correlation with the building's realized global drifts. As already noted, all global drifts are lower than those in the undamaged building, except for the first and second scenario in the X direction and the fourth scenario in the Y direction, so that higher values for these inter-storey drifts cannot be realized since the early appearance of collapse state.

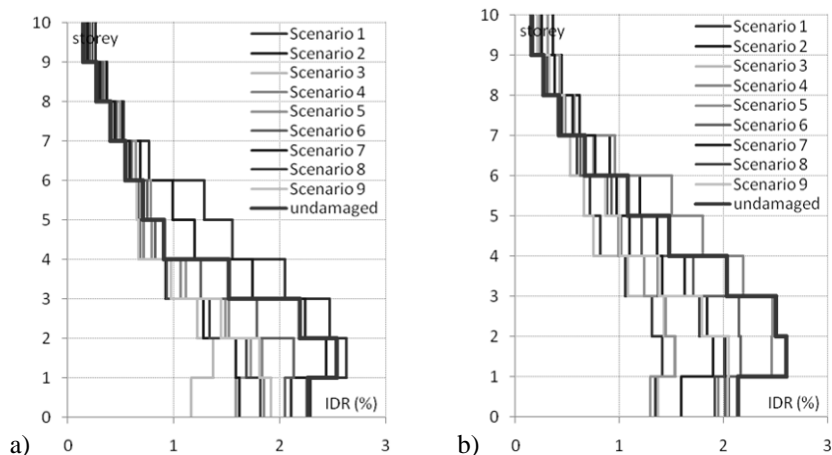

Slika 12. Međuspratni driftovi IDR za maksimalno realizovan nivo pomeranja (kolapsno stanje) 3D modela okvirne zgrade: a) X pravac, b) Y pravac

Figure 12. Inter-storey drifts IDR for the maximum realized displacements (collapse state) of the 3D frame building model: a) X direction, b) Y direction

4.7 Postprocesiranje rezultata numeričkih analiza: analiza oštećenja

U četvrtom delu istraživanja proračunati su koeficijenti oštećenja C_d za sve predefinisane scenarije. Na slici 13 prikazani su trilinearni splajnom interpolirani modeli originalnih *pushover* krivih za X pravac za devet predefinisanih scenarija oštećenja zgrade. Takođe, prikazani su i koeficijenti oštećenja C_d u procentima. U slučaju prvog scenarija, koeficijent oštećenja C_d jeste najniži, pri čemu postoji značajno odstupanje oštećene u odnosu na neoštećenu zgradu. Smanjena je vrednost nosivosti u nelinearnom domenu i postoji inicijalno pomeranje usled kolapsa stubova prizemlja. Međutim, vrednost maksimalno realizovane duktilnosti oštećene zgrade, prema ovom scenariju, jeste veća od vrednosti maksimalno realizovane duktilnosti neoštećene zgrade. Ova činjenica ukazuje na to da je usled povećanja duktilnosti sistema disipacija histerezisne energije veća, pa s obzirom na tu činjenicu, procena ukupnog oštećenja zgrade je na nižem nivou. U odnosu na prvi i drugi scenario, gde su realizovane veće maksimalne duktilnosti sistema, prilikom ostalih scenarija realizovane su manje vrednosti duktilnosti sistema. Tako, na primer,

4.7 Post-processing the results of numerical analyses: damage analysis

In the fourth part of the research damage coefficients C_d for all pre-defined scenarios were calculated. Figure 13 shows the tri-linear spline interpolated models of the original pushover curves in X direction for the nine pre-defined damage scenarios. Damage coefficients C_d are also presented in percentages. Damage coefficient C_d is the lowest in the case of the first scenario, whereby there is a significant deviation between the damaged and the undamaged building. The value of load bearing capacity in the non-linear domain is reduced and there is an initial displacement due to the collapse of ground-floor columns. However, in this scenario, the value of maximum realized ductility of the damaged building is higher than the value of maximum realized ductility of the undamaged building. This fact indicates that higher system ductility leads to higher dissipation of hysteresis energy, so that assessed damage to the building is lower. Compared to the first and the second scenario, where higher maximum system ductility values were realized, in other scenarios lower system ductility values were realized. Thus, for example, the highest value of

u slučaju trećeg scenarija, dobijena je najviša vrednost koeficijenta oštećenja C_d , s obzirom na to što je realizovana najniža vrednost maksimalne duktilnosti i najniža vrednost nosivosti u nelinearnom domenu.

damage coefficient C_d is obtained for the third scenario, given the lowest maximum realized ductility value, and the lowest bearing capacity value in the non-linear domain.

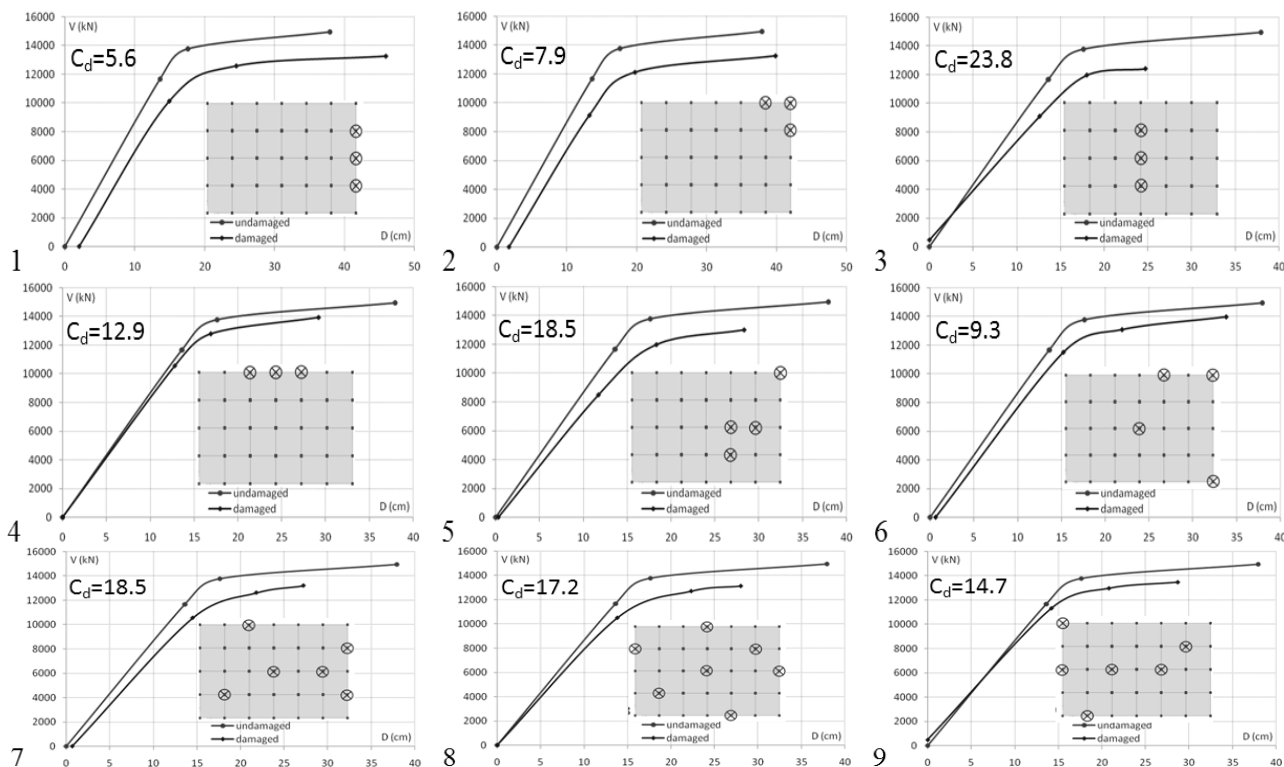

Slika 13. Trilinearni splajnom interpolirani modeli originalnih pushover krivih za X pravac za predefinisana scenarija oštećenja zgrade (kolaps stubova u prizemlju)

Figure 13. Tri-linear spline interpolated models of original pushover curves in X direction for pre-defined damage scenarios (collapse of the ground-floor columns)

Na slici 14 prikazani su trilinearni splajnom interpolirani modeli originalnih *pushover* krivih za Y pravac za devet predefinisanih scenarija oštećenja zgrade. U slučaju četvrtog scenarija, koeficijent oštećenja C_d jeste najniži, pri čemu postoji značajno odstupanje oštećene u odnosu na neoštećenu zgradu. Slično kao kod prvog scenarija, za X pravac i ovde je smanjena vrednost nosivosti u nelinearnom domenu uz postojanje inicijalnog pomeranja usled kolapsa stubova prizemlja. U odnosu na četvrti scenario, gde su realizovane veće maksimalne duktilnosti sistema, prilikom ostalih scenarija realizovane su manje vrednosti duktilnosti sistema. Prilikom petog scenarija dobijena je najveća vrednost koeficijenta oštećenja C_d , budući da je ovde realizovana najniža vrednost maksimalne duktilnosti, uz smanjenu nosivost sistema u nelinearnom domenu.

Figure 14 presents the tri-linear spline interpolated models of original pushover curves in Y direction for nine pre-defined damage scenarios. Damage coefficients C_d are the lowest in the case of the fourth scenario, whereby there is a significant deviation between the damaged and undamaged building. Similar to the case in the first scenario in X direction, the value of the load bearing capacity in the non-linear domain is also reduced and there is also an initial displacement induced by the collapse of ground-floor columns. Compared to the fourth scenario, where higher maximum system ductility values were realized, in other scenarios lower system ductility values were realized. The highest value of damage coefficient C_d is obtained for the fifth scenario, given the lowest maximum realized ductility value, accompanied by reduced bearing capacity of the system in the non-linear domain.

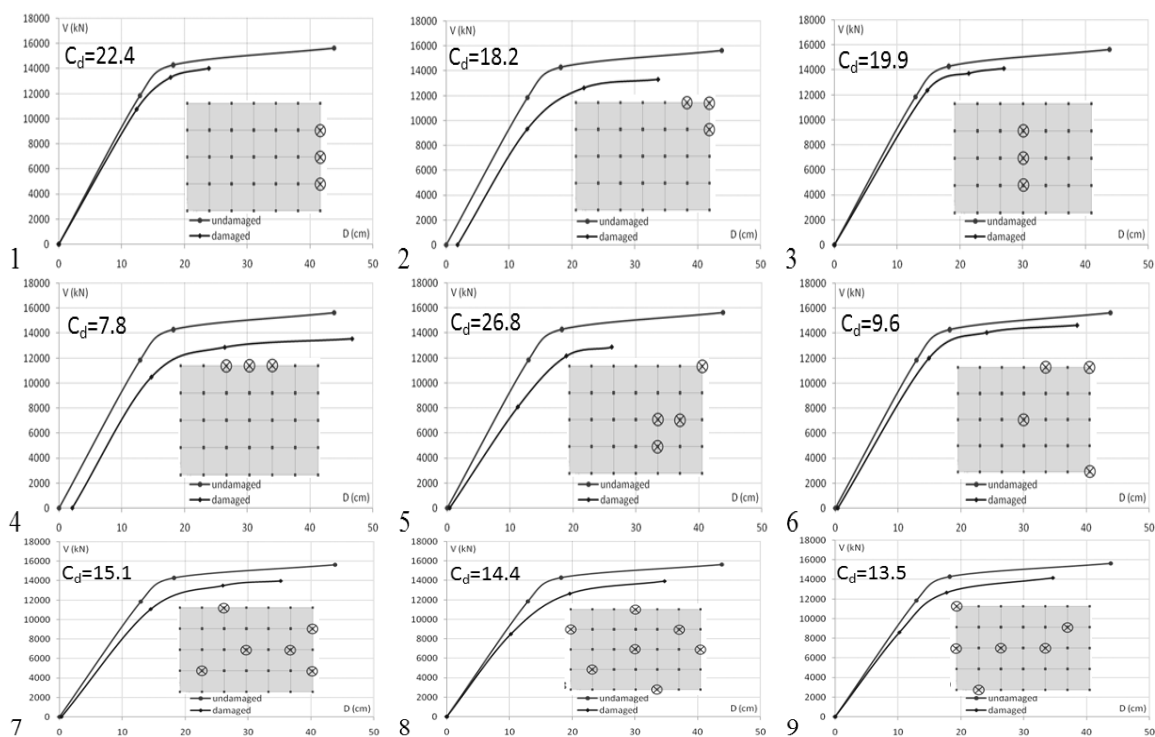

Slika 14. Trilinearni splajnom interpolirani modeli originalnih pushover krivih za Y pravac za predefinisana scenarija oštećenja zgrade (kolaps stubova u prizemlju)
 Figure 14. Tri-linear spline interpolated models of original pushover curves in Y direction for pre-defined damage scenario (collapse of the ground-floor columns)

5 ZAKLJUČAK

Na osnovu razvijene metodologije i sprovedenih nelinearnih numeričkih analiza 3D modela zgrade, utvrđeno je da su globalni driftovi pri nivou ciljnog pomeranja, a određeni za isti nivo seizmičkog zahteva, manji kod neoštećene zgrade od globalnih driftova za scenarija oštećenja zgrade. Međutim, globalni driftovi za maksimalno realizovan nivo pomeranja (kolapsno stanje) mogu biti veći kod neoštećene zgrade, u odnosu na globalne driftove za scenarija oštećenja zgrade. Ovo je posledica toga što prilikom određenih scenarija oštećenja zgrade kolaps nastupa znatno ranije, nego što je to slučaj kod neoštećene zgrade, pa i nije moguće realizovati veći nivo pomeranja. Na taj način, stiče se utisak da je kod određenih scenarija oštećenja zgrade realizovan manji nivo povredljivosti, nego što je to slučaj kod neoštećene zgrade. U tom smislu, potrebno je proanalizirati koliko su maksimalna realizovanja pomeranja i nivou iniciranja kolapsa zgrade. S druge strane, međuspratni driftovi pri nivou ciljnog pomeranja 3D modela okvirne zgrade, određeni za isti nivo seizmičkog zahteva, mogu pokazati koliki je stepen povredljivosti oštećene zgrade, u odnosu na neoštećenu zgradu. U ovom slučaju, utvrđeno je da su međuspratni driftovi gotovo svi niži kod neoštećene zgrade, dok su kod određenih scenarija oštećene zgrade razvijani veći međuspratni driftovi čak i kod viših spratova koji nisu bili direktno oštećeni. To znači da se inicijalno oštećenje usled incidentnog dejstva povećalo pri dodatnom seizmičkom dejstvu. Međuspratni driftovi za maksimalno

5 CONCLUSION

Based on the developed methodology and non-linear numerical analysis of the 3D building model conducted, it has been concluded that global drifts at the level of target displacement obtained for the same level of seismic demand are lower in the undamaged building than global drifts in damaged-building scenarios. However, global drifts for the maximum realized displacement (collapse state) may be higher in the undamaged building than global drifts in the damaged-building scenarios. This is due to the fact that in certain damaged-building scenarios the collapse appears much earlier than it is the case with the undamaged building, so higher levels of displacement cannot be realized. Thus, one can get the impression that in certain damaged-building scenarios a lower level of vulnerability has been realized in comparison with the undamaged building. Therefore, it is necessary to identify the maximum realized displacement and the building's collapse initiation level. However, inter-storey drifts at the target displacement level of the 3D frame building model, determined for the same level of seismic demand, can indicate the degree of vulnerability of the damaged building compared to the undamaged building. In this case, almost all inter-storey drifts found in undamaged buildings were lower, while in some damaged-building scenarios higher inter-storey drifts were developed even in higher stories that were indirectly damaged. This means that the initial damage induced by accidental action has increased with the

realizovan nivo pomeranja (kolapsno stanje) neoštećene zgrade mogu biti veći nego kod oštećene zgrade, ali njih treba razmatrati u kontekstu s globalnim driftovima. U ovom slučaju, određivani su međuspratni driftovi za različite vrednosti globalnih driftova, a s obzirom na to što su kod skoro svih scenarija oštećenja zgrade realizovane znatno manje vrednosti globalnih driftova, moglo se i očekivati da će njihovi odgovarajući međuspratni driftovi biti manji. Međutim, kod viših spratova, oni su i za znatno manje vrednosti globalnih driftova veći nego u slučaju neoštećene zgrade.

Na osnovu definisanog i analiziranog koeficijenta oštećenja zgrade, može se pouzdano i veoma brzo odrediti stepen oštećenja sistema u kapacitativnom domenu. Potrebno je poznavati samo četiri parametra (inicijalno stanje, granica tečenja, nivo ojačanja/omekšanja i nivo maksimalnog pomeranja), kako bi se modeli originalnih *pushover* krivih veoma efikasno i tačno aproksimirali kroz interpolaciju trilinearnim splajnom. Generalno, može se zaključiti da - ukoliko je realizovan kolaps stubova prizemlja, a koji su neposredno jedan uz drugi - tada se može očekivati značajan stepen oštećenja zgrade. U ovom slučaju i kolaps manjeg broja stubova može predstavljati kritičniju situaciju u odnosu na neki drugi raspored većeg broja stubova. Ukoliko je realizovan kolaps stubova koji nisu na bliskoj udaljenosti, tada je i stepen oštećenja niži u odnosu na prethodno izveden stav. S druge strane, svaki model zgrade je poseban problem, pa detaljnija generalizacija nije ni moguća, jer se zahteva multiparametarski pristup u rešavanju ovakvih složenih problema, kao što je prikazano metodologijom razvijenom u ovom istraživanju.

Zahvalnost

Prikazano istraživanje podržalo je Ministarstvo prosvete, nauke i tehnološkog razvoja Republike Srbije (Projekat br. TR 36043).

6 LITERATURA REFERENCES

- [1] Adam C., Jager C.: *Dynamic Instabilities of Simple Inelastic Structures Subjected to Earthquake Excitation*, Advanced Dynamics and Model-Based Control of Structures and Machines, Springer, pp. 11-18, 2012.
- [2] Adam C., Jager C.: *Seismic Induced Global Collapse of Non-deteriorating Frame Structures*, M. Papadrakakis et al. (eds.): Computational Methods in Earthquake Engineering, Springer, pp. 21-40, 2012.
- [3] ATC 40, *Seismic Evaluation and Retrofit of Concrete Buildings*, Vol. 1, Applied Technology Council, Redwood City, USA, 1996.
- [4] Bradley B., Dhakal R., Mander J.: *Modeling and Analysis of Multi-Storey Buildings Designed to Principles of Ductility and Damage Avoidance*, The 10th East Asia and Pacific Conference on Structural Engineering and Construction, Bangkok, Thailand, pp. 1-6, 2006.
- [5] Chung Y., Meyer C., Shinozuka M.: *Seismic Damage Assessment of RC Members*, Report NCEER-87-0022, National Center for Earthquake Engineering Research, State University of New York at Buffalo, 1987.
- [6] Čosić M., Brčić S.: Metodologija pripreme i obrade akcelorograma za linearne i nelinearne seizmičke analize konstrukcija, *Časopis Izgradnja*, Vol. 66, No. 11-12, str. 511-526, 2012.
- [7] DiPasquale E., Cakmak A.: *Detection and Assessment of Seismic Structural Damage*, Report NCEER-87-0015, National Center for Earthquake Engineering Research, State University of New York at Buffalo, 1987.
- [8] EN 1992, *Design of Concrete Structures - Part 1-1: General Rules and Rules for Buildings*, European Committee for Standardization, Belgium, 2003.
- [9] EN 1998, *Design of Structures for Earthquake Resistance - Part 1: General Rules, Seismic Actions and Rules for Buildings*, European Committee for Standardization, Belgium, 2004.

additional seismic action. Inter-storey drifts for the maximum realized displacement (collapse state) of the undamaged building can be higher than those of the damaged building, but they should be considered in context with global drifts. In this case, inter-storey drifts were determined for various global drift values, as in almost all damage scenarios significantly lower global drift values were realized, which could have been expected provided that their corresponding inter-storey drifts were lower. However, at higher stories they were higher for even much lower global drift values than in the undamaged building.

Based on the defined and analyzed damage coefficient, the degree of damage to the system in the capacitive domain can be reliably and quickly identified. It requires only four parameters (the initial state, the yielding state, the level of hardening/softening and the level of maximum displacement) in order to approximate the models of original pushover curves very efficiently and accurately using tri-linear spline interpolation. Generally, it can be concluded that with the collapse of adjacent ground-floor columns, a significant degree of damage to the building can be expected. Thus, the collapse of few columns can lead to critical situation, as compared to some other arrangement with larger number of columns. With the collapse of columns that are not in the near distance, the degree of damage is also lower than in the above case. However, each building model makes an individual problem, which disables further generalization since solving such a complex problem requires the multi-parameter approach, as shown by the methodology developed in this research.

Acknowledgement

The presented work has been supported by The Ministry of Education and Science of the Republic of Serbia (Project No. TR 36043).

- [10] Fahjan Y., Ozdemir Z., Keypour H.: Procedures for Real Earthquake Time Histories Scaling and Application to Fit Iranian Design Spectra, The 5th Iranian Conference on Seismology and Earthquake Engineering, Paper No. 164, pp. 1-8, Iran, Tehran, 2007.
- [11] FEMA 273, *NEHRP Guidelines for the Seismic Rehabilitation of the Buildings*, Building Seismic Safety Council, Applied Technology Council, Federal Emergency Management Agency, Washington D. C., USA, 1997.
- [12] FEMA 274, *NEHRP Commentary on the Guidelines for the Seismic Rehabilitation of the Buildings*, Building Seismic Safety Council, Applied Technology Council, Federal Emergency Management Agency, Washington D. C., USA, 1997.
- [13] FEMA 356, *Pre-Standard and Commentary for the Seismic Rehabilitation of Buildings*, American Society of Civil Engineers, Federal Emergency Management Agency, Washington D. C., USA, 2000.
- [14] Folić R., Čosić M.: *Vulnerability of Damaged Structures: The Concept of the Scenario of Related Non-Linear Analyses*, International Conference on Civil Engineering Design and Construction (Science and Practice), pp. 14-26, Varna, Bulgaria, 2014.
- [15] Ghobarah A., Abou-Elfath H., Biddah A.: *Response-Based Damage Assessment of Structures*, Earthquake Engineering and Structural Dynamics, Vol. 28, Iss. 1, pp. 79-104, 1999.
- [16] Goulet C., Haselton C., Mitrani-Reiser J., Beck J., Deierlein G., Porter K., Stewart J.: *Evaluation of the Seismic Performance of a Code-Conforming Reinforced-Concrete Frame Building: From Seismic Hazard to Collapse Safety and Economic Losses*, Earthquake Engineering and Structural Dynamics, Vol. 36, Iss. 13, 2007.
- [17] Haselton C., Liel A., Deierlein G., Brian D., Chou J.: *Seismic Collapse Safety of Reinforced Concrete Buildings. I: Assessment of Ductile Moment Frames*, Journal of Structural Engineering, Vol. 137, Iss. 4, pp. 481-491, 2011.
- [18] http://www.isesd.hi.is/ESD_Local/frameset.htm
- [19] Jeong S., Elnashai A.: *Analytical and Experimental Seismic Assessment of Irregular RC Buildings*, The 13th World Conference on Earthquake Engineering, Paper No. 113, Vancouver, Canada, pp. 1-15, 2004.
- [20] Ladjinovic Dj., Folic R.: *Application of Improved Damage Index for Designing od Earthquake Resistant Structures*, The 13th World Conference on Earthquake Engineering, Paper No. 2135, Vancouver, Canada, pp. 1-15, 2004.
- [21] Liel A., Haselton C., Deierlein G.: *Seismic Collapse Safety of Reinforced Concrete Buildings. II: Comparative Assessment of Nonductile and Ductile Moment Frames*, Journal of Structural Engineering, Vol. 137, Iss. 4, pp. 492-502, 2011.
- [22] Lieping Y., Zhe Q.: *Failure Mechanism and Its Control of Building Structures Under Earthquakes Based on Structural System Concept*, Journal of Earthquake and Tsunami, Vol. 3, Iss. 4, pp. 249-259, 2009.
- [23] Liolios A., Hatzigeorgiou G., Liolios A.: *Efekat višestrukih zemljotresa na seizmički odgovor konstrukcije, Građevinski materijali i konstrukcije*, Vol. 55, Iss. 4, pp. 3-14, 2012.
- [24] Loh C-H., Chao A-H.: *The Use of Damage Function in Performance-Based Seismic Design of Structures*, The 13th World Conference on Earthquake Engineering, Paper No. 3257, Vancouver, Canada, pp. 1-15, 2004.
- [25] Maeda M., Nakano Y., Lee K.: *Post-Earthquake Damage Evaluation for R/C Buildings Based on Residual Seismic Capacity*, The 13th World Conference on Earthquake Engineering, Paper No. 1179, Vancouver, Canada, pp. 1-15, 2004.
- [26] Manafpour A.: *A Damage-Controlled Force-Based Seismic Design Method for RC Frames*, The 13th World Conference on Earthquake Engineering, Paper No. 2670, Vancouver, Canada, pp. 1-22, 2004.
- [27] Nakano Y, Maeda M, Kuramoto H, Murakami M.: *Guideline for Post-Earthquake Damage Evaluation and Rehabilitation of RC Buildings in Japan*, The 13th World Conference on Earthquake Engineering, Paper No. 124, Vancouver, Canada, 2004.
- [28] Park Y., Ang A., Wen Y.: *Seismic Damage Analysis of Reinforced Concrete Buildings*, Journal of Structural Engineering, Vol. 111, Iss. 4, pp. 740-757, 1985.
- [29] Park Y., Ang A., Wen Y.: *Damage-Limiting Aseismic Design of Buildings*, Earthquake Spectra, Vol. 3, Iss. 1, pp. 1-26, 1987.
- [30] Roufaiel M., Meyer C.: *Reliability of Concrete Frames Damaged by Earthquakes*, Journal of Structural Engineering, Vol. 113, Iss. 3, pp. 445-457, 1987.
- [31] Takada T., Nakano T.: *Seismic Load Effect Directly Linked to Specified Collapse Mechanisms in Ultimate Limit State Design*, The 12th World Conference on Earthquake Engineering, Paper No. 2560, Auckland, New Zealand, pp. 1-9, 2000.
- [32] Vamvatsikos D., Cornell A.: *Seismic Performance, Capacity and Reliability of Structures as Seen Through Incremental Dynamic Analysis*, The John A. Blume Earthquake Engineering Center, Report No. 151, USA, 152p, 2005.
- [33] Williams M., Sexsmith R.: *Seismic Damage Indices for Concrete Structures: A State-of-the-Art Review*, Earthquake Spectra, Vol 11, Iss. 2, pp. 319-349, 1995.

REZIME

ANALIZA PERFORMANSI OŠTEĆENIH OBJEKATA, PRIMENOM SCENARIJA POVEZANIH NELINEARNIH ANALIZA I KOEFICIJENTA OŠTEĆENJA

Mladen ĆOSIĆ
Radomir FOLIĆ

U radu je razvijena i prikazana metodologija za analizu oštećenja objekata koji su izloženi incidentnom i seizmičkom dejstvu. Procedura se bazira na nelinearnim numeričkim analizama, uvažavajući principe projektovanja konstrukcija prema seizmičkim performansama (PBSD). Matrica krutosti za uticaje vertikalnog dejstva koristi se kao inicijalna matrica krutosti prilikom nelinearne analize kojom se simulira kolaps pojedinačnih stubova prizemlja, formirajući nekoliko mogućih scenarija. Matrica krutosti na kraju analize, kojom se simulira kolaps pojedinačnih stubova, koristi se kao inicijalna matrica krutosti prilikom nelinearne statičke *pushover* analize (NSPA) za bidirekciono seizmičko dejstvo (X i Y pravac). Analize ciljnog pomeranja sprovedene su prema metodi spektra kapaciteta (CSM). Procena stanja zgrade je sprovedena na osnovu proračunatih globalnih i međuspratnih driftova i razvijenog koeficijenta oštećenja. Razmatranje stanja oštećenja zgrade utvrđeno je integralnim pristupom i preko globalnih i preko međuspratnih driftova, tako da se - u zavisnosti od nivoa pomeranja za koji se driftovi određuju - dobija pouzdaniji odgovor. Primenom koeficijenta oštećenja može se dobiti veoma brz, pouzdan i dovoljno precizan odgovor kada je reč o nivou oštećenja kompletne zgrade u kapacitativnom domenu, od elastičnog, preko nelinearnog, pa sve do stanja kolapsa.

Ključne reči: nelinearna analiza, scenario, incidentno i seizmičko dejstvo, koeficijent oštećenja

SUMMARY

PERFORMANCE ANALYSIS OF DAMAGED BUILDINGS APPLYING SCENARIO OF RELATED NON-LINEAR ANALYSES AND DAMAGE COEFFICIENT

Mladen COSIC
Radomir FOLIC

The paper deals with methodology developed and presented for analyzing the damage on structures exposed to accidental and seismic actions. The procedure is based on non-linear numerical analysis, taking into account the principles of *Performance-Based Seismic Design* (PBSD). The stiffness matrix of the effects of vertical action is used as the initial stiffness matrix in non-linear analysis which simulates the collapse of individual ground-floor columns, forming thereby a number of possible scenarios. By the end of the analysis that simulates the collapse of individual columns, the stiffness matrix is used as the initial stiffness matrix for *Non-linear Static Pushover Analysis* (NSPA) of bi-directional seismic action (X and Y directions). Target displacement analyses were conducted using the *Capacity Spectrum Method* (CSM). The structure's conditions/state was assessed based on the calculated global and inter-storey drifts and the damage coefficient developed. The damage level to the building was established using an integrated approach based on global and inter-storey drifts, so that, depending on the level of displacements for which the drifts are identified, a more reliable answer can be obtained. Applying the damage coefficient, a prompt, reliable and accurate indication can be obtained on the damage level to the entire structure in the capacitive domain, from elastic and non-linear to collapse state.

Keywords: non-linear analysis, scenario, accidental and seismic action, damage coefficient

COMPUTER MODELLING OF STRUCTURES WITH ACCOUNT OF THE CONSTRUCTION STAGES AND THE TIME DEPENDENT MATERIAL PROPERTIES

NUMERIČKO MODELIRANJE KONSTRUKCIJA UZ UVOĐENJE FAZA GRAĐENJA I SVOJSTAVA MATERIJALA ZAVISNIH OD VREMENA

Alexander TRAYKOV
Raina BOIADJIEVA

PRETHODNO SAOPŠTENJE
PRELIMINARY REPORT
UDK: 624.01:519.711
doi: 10.5937/grmk1503029T

1 GENERAL

The usual way engineers calculate and design structures is assuming that they are completely built and loaded by the loads defined by the codes, including the live loads. The way and the sequence the structures are constructed is not taken into account in the design with few exceptions.

Those exceptions are some types of bridges, some assembled structures and structures with complex shapes. There are only some very general recommendations about those issues written in the codes. For the rest of the structures taking into account the influence of the sequence of construction is carried out upon designer's decision. An "ordinary" plane frame is considered in the present article. The analysis that is carried out reveals that even in an "ordinary" structure there are elements which are sensitive to the construction sequence and the construction stages shall be taken into account for their design.

Associate Professor Alexander Traykov, MSc, PhD,
University of Architecture, Civil Engineering and Geodesy,
Department of Structural Mechanics, 1 Hristo Smirnenski
Blvd, Sofia, Bulgaria, e-mail: traykovalexander@gmail.com
Raina Boiadjieva, MSc, Civil/Structural Engineer, University
of Architecture, Civil Engineering and Geodesy, Department
of Structural Mechanics, 1 Hris to Smirnenski Blvd, Sofia,
Bulgaria, e-mail: r_boiadjieva@abv.bg

2 DESCRIPTION OF THE STRUCTURE AND THE LOADING

2.1 Description of the structure

An example of a single frame that is a part of a family house structure is considered (fig. 1). It is a two span three-storey frame and the two spans are of 6 and 7.20 m respectively. The storey height is 3 m. The specific feature of the structure is that the top floor is shifted by 1.20 m because of architectural reasons.

Thus, the beam at the floor below supports the two columns at the façades. The soil conditions are not taken into account and the frame supports are considered as fixed. The dimensions of the beams are 25/60 cm, and the columns are 25/40 cm. The properties of concrete grade C25/30 are used in the calculations

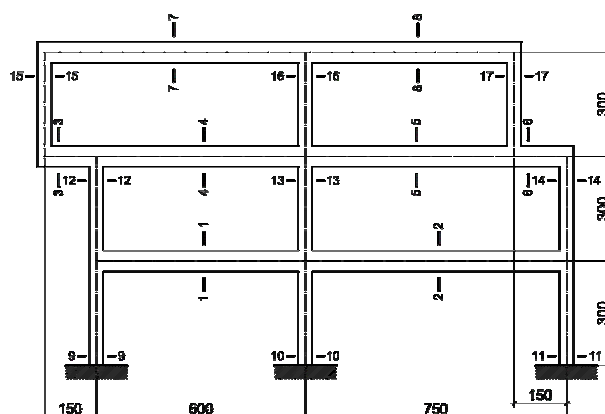

Figure 1: Frame

2.2 Description of the loading

The loads are as follows: Self-weight – it is automatically calculated by the software; Wall on the beams – 14,62 kN/m; Load on the beams due to the corresponding part of the slab – 27,12 kN/m; Live load on the beams due to the corresponding part of the slab – 9,0 kN/m.

Only static analysis of the frame is carried out. The coefficient is $\psi = 1$ as the results are used only for the comparison of three different ways of loading.

The construction stages considered in the analysis correspond to the construction schedule presented below.

day	
0	Disassembling of the formwork of the 1 floor after the concrete has aged for 28 days
7	Constructed formwork and structure of the second floor
35	Disassembling of the second floor of the frame
42	Constructed formwork and structure of the third floor
70	Disassembling of the third floor of the frame
77	The frame is loaded by the masonry walls
105	The frame is loaded by live load and snow

3 NUMERICAL MODEL

The analysis software SAP2000 [1] is used for modelling and structural calculations. The beams and the columns are modelled with Frame elements with rectangular sections. Elements nodes are defined at 50 cm distance (fig.2).

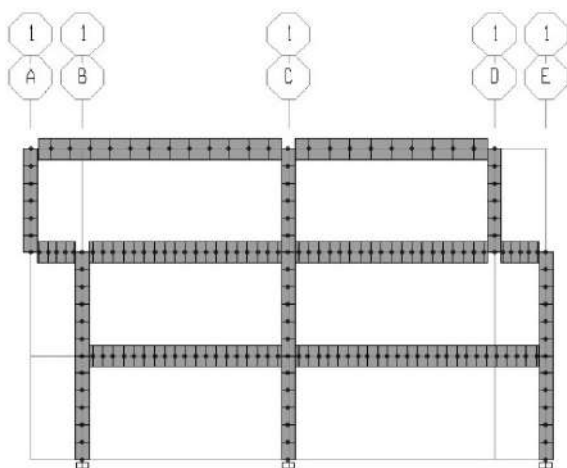

Figure 2: Model

Construction stages where the formwork transfers the loading from the already concreted structural part to the structure below are modelled by means of weightless frame elements. The modelling does not aim to investigate the influence of the formwork on the structural behaviour. The purpose of the modelling is to

study the structural behaviour during the sequential construction stages and the influence of separate factors - creep, shrinkage, change of modulus of elasticity and combination of those factors, on the structural behaviour.

3.1 Three different variants of defining the loading are considered and modelled numerically:

- 3.1.1 The loads are defined and combined in the way that is usual in engineering - they act simultaneously on the structure that is idealized in the numerical (most often finite element) model. The main assumptions are as follows: deformations due to the self-weight of the structural elements during construction are not taken into account and it is also not considered that the rest of the loads are applied to the structure after the elements are deformed due to their self-weight. The results are presented in the following tables under the name COMBO.
- 3.1.2 The loads (walls and live load) are applied to the already constructed structure that is deformed because of the self-weight in the second variant. The results are presented in the following tables under the name STAGES.
- 3.1.3 The third variant is similar to the second one but the time dependent material properties (TDMP) of the concrete are taken into account. Those properties are introduced in the software according to the definitions and recommendations presented in CEB-FIP 90 [2]. The results are presented in the tables below under the name of STAGES+TDMP.

The load cases and their combinations are same for three variants of loading.

3.2 Main relations for modelling the TDMP that are defined in CEB-FIP 90 [2] and used by SAP2000

The main relations defined in CEB-FIP 90 that are used in the analysis carried out by means of SAP2000 software are presented in the text below.

- 3.2.1 Elastic deformation. That deformation is presented

in the form $E_{ci}(t) = E_{ci} \sqrt{\beta_{cc}(t)}$, where $E_{ci}(t)$ is the modulus of elasticity for concrete at day t , and E_{ci} is the modulus of elasticity at the 28th day,

$\beta_{cc}(t) = \exp\left\{s \left[1 - \left(\frac{28}{t}\right)^{0.5}\right]\right\}$ is factor depend-

ing on the age of concrete and cement type. The coefficient s that corresponds to the concrete grade is introduced in the software. For concrete grade C25/30 with $f_{cm} = 33\text{MPa}$ $s=0.25$. The analysis and the conclusions are carried out assuming that the formwork for the previous construction stage is removed before constructing the next stage.

3.2.2 Creep of concrete. For constant stress at time t_0

the deformation is $\varepsilon_{cc} = \frac{\sigma_c(t_0)}{E_{ci}} \phi(t, t_0)$, where

$\sigma_c(t_0)$ is the stress that corresponds to the age of loading t_0 , $\phi(t, t_0)$ is creep factor that can be calculated as $\phi(t, t_0) = \beta_c(t - t_0)\phi_0$, and β_c is factor, describing the creep in the period after the loading, t [days] is the age of the concrete, t_0 is the age of the concrete at the time of loading:

$$\phi_0 = \phi_{RH} \beta(f_{cm}) \beta(t_0),$$

$$\phi_{RH} = 1 + \frac{1 - \left(\frac{RH}{RH_0}\right)}{0.46 \left(\frac{h}{h_0}\right)^{\frac{1}{3}}},$$

$$\beta(f_{cm}) = \frac{5.3}{\sqrt{\frac{f_{cm}}{f_{cm0}}}},$$

$$\beta(t_0) = \frac{1}{0.1 + \left(\frac{t_0}{t_1}\right)^{0.2}}.$$

All the quantities are defined in the text above. The relation between the creep and time is given by:

$$\beta(t - t_0) = \left[\frac{(t - t_0)/t_1}{\beta_H + (t - t_0)/t_1} \right],$$

$$\beta_H = 150 \left\{ 1 + \left(1.2 \frac{RH}{RH_0} \right)^{18} \right\} \frac{h}{h_0} + 250 \leq 1500$$

Where $t_1 = 1$ day, $RH_0 = 1000$ and $h_0 = 100$. The relative humidity [%] of the environment is introduced in the software as input data. The relative humidity is assumed in the analysis as equal to 80% that corresponds to open environment according to CEB- FIP 90.

3.2.3 Shrinkage of concrete:

$\varepsilon_{cs}(t, t_s) = \varepsilon_{cso} \cdot \beta_s(t - t_s)$, where ε_{cso} is notional shrinkage coefficient, β_s is factor, describing the shrinkage process related to time, t is the age of the concrete and t_s is the age of the concrete when the shrinkage begins. Notional

shrinkage coefficient can be calculated according to $\varepsilon_{cso} = \varepsilon_s(f_{cm}) \beta_{RH}$,

$$\varepsilon_s(f_{cm}) = \left[160 + 10 \beta_{sc} \left(9 - \frac{f_{cm}}{f_{cm0}} \right) \right],$$

where f_{cm} is the main concrete compression strength [MPa] at the age of 28 days, f_{cm0} is assumed 10 MPa, β_{sc} is factor of magnitude between 4 and 8, that depends on the cement type. The last factor is assumed as equal to 5 in the analysis.

$$\beta_{RH} = -1.55 \beta_{sRH} \rightarrow 40\% \leq RH < 99\%$$

$$\beta_{RH} = 0.25 \rightarrow RH > 99\%$$

where $\beta_{sRH} = 1 - \left(\frac{RH}{RH_0}\right)^3$, where **RH** is the relative humidity [%] of the environment (atmosphere) and RH_0 is 100%. The relation between shrinkage and time is given by:

$$\beta_s(t - t_s) = \sqrt{\frac{(t - t_s)/t_1}{350(h/h_0) + (t + t_s)/t_1}},$$

where h is the notional size of member [mm] that is given by $h = \frac{2A_c}{u}$, where A_c is the cross

section area, and u is the parameter of the cross section part subjected to shrinkage; $h_0 = 100\text{mm}$ and $t_1 = 1$ day.

4 ANALYSIS AND COMPARISON OF THE RESULTS

The main results of the calculations of three variants of modelling are compared. The loads are the same for all the models but the load cases are defined in different way. The results present the vertical and horizontal displacements and the internal forces at 17 particular sections of the frame elements. Those sections are shown on fig.1. The results are compared and the comparison is analyzed in order to show the influence of the construction stages and the time dependent material properties on the distribution of forces and displacements that correspond to particular load values:

4.1 Elastic analysis (COMBO)

The displacements and the internal forces in specific sections of the frame elements are shown below.

	1	2	3	4	5	6	7	8	9	10	11	12	13	14	15	16	17
u3 [m]	-0,002	-0,005	-0,003	-0,001	-0,008	-0,005	-0,008	-0,005	0,000	0,000	0,000	-0,001	-0,002	-0,001	-0,004	-0,002	-0,005
u1 [m]	0,000	0,000	-0,002	-0,002	-0,002	-0,002	-0,003	-0,003	0,000	0,000	0,000	-0,002	-0,002	-0,001	-0,004	-0,003	-0,003
M [kNm]	86,64	148,59	25,58	5,01	192,01	215,19	150,74	64,27	-26,20	-12,06	30,64	-3,34	63,52	-95,32	68,85	4,43	-8,80
Q [kN]	-13,73	-3,11	152,65	-50,09	-23,49	191,73	-12,84	10,73	-24,09	-9,54	33,63	-21,54	-55,31	76,86	-17,31	-23,80	41,10
N [kN]	-2,54	43,23	17,31	-4,24	-35,75	-76,85	-17,31	-41,10	-574,75	-1190,94	-473,95	-416,50	-771,60	-274,71	-146,41	-382,03	-94,54

4.2 The results corresponding to numerical modelling of the construction stages (STAGES)

	1	2	3	4	5	6	7	8	9	10	11	12	13	14	15	16	17
u3 (105)[m]	-0,002	-0,006	-0,003	-0,001	-0,008	-0,005	-0,008	-0,004	0,000	0,000	0,000	-0,001	-0,002	-0,001	-0,003	-0,002	-0,003
u1 (105)[m]	0,000	0,000	-0,002	-0,002	-0,002	-0,002	-0,003	-0,003	0,000	0,000	0,000	-0,001	-0,002	-0,001	-0,003	-0,002	-0,003
M (105) [kNm]	90,29	157,99	32,67	6,10	210,52	211,11	152,70	69,40	-30,28	-15,87	36,48	-8,23	65,62	-97,68	65,72	-3,18	-12,59
Q (105) [kN]	-8,89	-7,41	151,66	-42,67	-30,72	185,68	-11,85	11,94	-27,80	-12,80	40,60	-10,65	-51,42	62,07	-13,22	-14,31	27,53
N (105) [kN]	-17,15	21,47	13,22	2,57	-34,54	-62,07	-13,22	-27,53	-561,49	-1214,54	-463,62	-408,09	-786,05	-268,67	-145,42	-381,84	-95,73

Comparison of the differences in % between the results of two solutions is presented in the table below.

COMBO/STAGES

	1	2	3	4	5	6	7	8	9	10	11	12	13	14	15	16	17
u3 (105)[m]	3%	8%	5%	18%	8%	7%	3%	27%				6%	8%	14%	4%	27%	38%
u1 (105)[m]	20%	38%	13%	14%	14%	14%	22%	22%				15%	9%	40%	18%	25%	27%
M (105) [kNm]	4%	6%	28%	22%	10%	2%	1%	8%	16%	32%	19%	146%	3%	2%	5%	28%	43%
Q (105) [kN]	35%	138%	1%	15%	31%	3%	8%	11%	15%	34%	21%	51%	7%	19%	24%	40%	33%
N (105) [kN]	575%	50%	24%	39%	3%	19%	24%	33%	2%	2%	2%	2%	2%	2%	1%	0%	1%

The two sets of results reveal differences in the elastic displacements and the internal forces. It can be seen that the bending moments in the beams are bigger when the construction stages are taken into account, while the shear and axial forces in the vertical elements at the top storey decrease.

The variation of the considered quantities – vertical and horizontal displacements, bending moments, axial and shear forces corresponding to the construction stages, is presented in the following tables.

Vertikal displacements (elastic)

day	1	2	3	4	5	6	7	8	9	10	11	12	13	14	15	16	17
0	-0,001	-0,003							0,000	0,000	0,000						
7	-0,002	-0,007							0,000	0,000	0,000						
35	-0,001	-0,003	0,000	-0,001	-0,004	-0,002			0,000	0,000	0,000	0,000	0,000	0,000			
42	-0,001	-0,003	0,000	-0,002	-0,007	-0,004			0,000	0,000	0,000	0,000	-0,001	0,000			
70	-0,001	-0,003	0,000	-0,002	0,000	-0,005	-0,003	-0,005	-0,002	0,000	0,000	0,000	0,000	-0,001	0,000	-0,002	-0,002
77	-0,002	-0,005	-0,002	-0,001	-0,007	-0,004	-0,005	-0,002	0,000	0,000	0,000	-0,001	-0,001	0,000	-0,002	-0,001	-0,002
105	-0,002	-0,006	-0,003	-0,001	-0,008	-0,005	-0,008	-0,004	0,000	0,000	0,000	-0,001	-0,002	-0,001	-0,003	-0,002	-0,003

Horizontal displacements (elastic)

day	1	2	3	4	5	6	7	8	9	10	11	12	13	14	15	16	17
0	0,000	0,000							0,000	0,000	0,000						
7	0,000	-0,001							0,000	0,000	0,000						
35	0,000	0,000	0,000	0,000	0,000	0,000			0,000	0,000	0,000	0,000	0,000	0,000			
42	0,000	0,000	-0,001	-0,001	-0,001	-0,001			0,000	0,000	0,000	-0,001	-0,001	0,000			
70	0,000	0,000	-0,001	-0,001	-0,001	-0,001	-0,001	-0,001	0,000	0,000	0,000	-0,001	-0,001	0,000	-0,002	-0,002	-0,001
77	0,000	0,000	-0,001	-0,001	-0,001	-0,001	-0,002	-0,002	0,000	0,000	0,000	-0,001	-0,001	0,000	-0,002	-0,001	-0,002
105	0,000	0,000	-0,002	-0,002	-0,002	-0,002	-0,003	-0,003	0,000	0,000	0,000	-0,001	-0,002	-0,001	-0,003	-0,002	-0,003

Bending moments

day	1	2	3	4	5	6	7	8	9	10	11	12	13	14	15	16	17
0	51,52	99,53							-17,89	-12,41	25,65						
7	103,33	199,46							-35,80	-28,43	51,32						
35	50,23	95,01	0,00	40,95	103,33	59,23			-17,30	-12,24	23,53	14,43	19,97	-43,64			
42	48,95	90,50	0,00	82,20	207,09	119,41			-16,70	-10,26	21,41	28,84	39,57	-87,26			
70	53,27	93,26	26,79	-3,98	132,68	130,82	104,02	49,43	-19,27	-10,30	23,12	-11,33	42,03	-59,12	42,28	-5,81	-9,87
77	75,33	133,80	23,30	14,93	172,90	160,93	102,94	46,94	-25,52	-14,29	31,49	-2,14	50,43	-78,78	43,97	-2,20	-8,28
105	90,29	157,99	32,67	6,10	210,52	211,11	152,70	69,40	-30,28	-15,87	36,48	-8,23	65,62	-97,68	65,72	-3,18	-12,59

Shear forces

day	1	2	3	4	5	6	7	8	9	10	11	12	13	14	15	16	17
0	2,49	-7,05							-16,43	-12,46	28,89						
7	9,50	-9,36							-32,85	-24,92	57,77						
35	-1,27	-5,35	0,00	2,69	-11,41	53,41			-15,17	-10,50	26,25	-10,49	-13,46	23,94			
42	-5,05	-3,65	3,88	10,17	-18,12	114,75			-15,07	-8,53	23,60	-20,97	-26,91	47,88			
70	-3,28	-6,22	103,81	-24,67	-22,79	113,41	-7,27	8,31	-17,70	-8,27	25,97	0,67	-30,46	29,79	-6,20	-5,10	11,30
77	-6,19	-6,72	104,38	-29,57	-24,71	141,75	-7,84	7,87	-23,39	-11,70	35,09	-9,50	-38,70	48,19	-8,28	-9,63	17,89
105	-8,89	-7,41	151,66	-42,67	-30,72	185,68	-11,85	11,94	-27,80	-12,80	40,60	-10,65	-51,42	62,07	-13,22	-14,31	27,53

Axial forces

day	1	2	3	4	5	6	7	8	9	10	11	12	13	14	15	16	17
0	-16,43	-28,89							-79,09	-252,83	-107,30						
7	-31,33	-55,38							-151,14	-498,93	-207,65						
35	-5,27	-2,31	0,00	-10,49	-23,94	-23,94			-213,44	-495,10	-216,22	-124,32	-241,49	-100,97			
42	5,90	24,28	0,00	-19,96	-45,64	-45,72			-340,94	-730,65	-318,16	-248,05	-482,52	-201,21			
70	-18,36	3,82	6,20	6,86	-18,49	-29,79	-6,20	-11,30	-341,23	-747,41	-275,34	-250,12	-494,93	-160,96	-97,57	-257,79	-65,12
77	-13,90	13,10	8,27	-1,22	-30,30	-48,19	-8,23	-17,89	-441,72	-963,21	-375,32	-312,61	-601,46	-211,23	-98,14	-257,66	-64,68
105	-17,15	21,47	13,22	2,57	-34,54	-62,07	-13,22	-27,53	-561,49	-1214,54	-463,62	-408,09	-786,05	-268,67	-145,42	-381,84	-95,73

4.3 Model that includes both the construction stages and TDMP of concrete.

	1	2	3	4	5	6	7	8	9	10	11	12	13	14	15	16	17
u3 (105)[m]	-0,004	-0,011	-0,005	-0,001	-0,014	-0,009	-0,011	-0,005	0,000	0,000	0,000	-0,001	-0,003	-0,001	-0,005	-0,002	-0,004
u1 (105)[m]	0,000	-0,001	-0,002	-0,002	-0,003	-0,003	-0,003	-0,004	0,000	0,000	0,000	-0,002	-0,003	-0,001	-0,004	-0,003	-0,003
M (105) [kNm]	91,52	157,90	30,25	3,01	214,06	182,97	151,94	69,62	-24,74	-15,84	30,93	-10,38	67,32	-96,46	63,49	-5,99	-13,92
Q (105) [kN]	-6,03	-9,61	150,64	-40,38	-33,25	208,89	-10,83	11,70	-24,41	-12,71	37,11	-8,41	-52,16	60,56	-13,23	-10,36	23,65
N (105) [kN]	-16,01	23,45	13,29	4,89	-36,91	-60,56	-13,29	-23,65	-555,22	-1225,64	-458,68	-404,88	-792,11	-265,96	-144,39	-383,06	-95,51

The differences in the results are presented in the table below:

COMBO/STAGES+TDMP

	1	2	3	4	5	6	7	8	9	10	11	12	13	14	15	16	17
u3 (105)[m]	84%	105%	37%	89%	90%	87%	44%	3%				72%	55%	69%	40%	5%	23%
u1 (105)[m]	53%	250%	8%	3%	28%	37%	1%	6%				9%	37%	15%	8%	2%	1%
M (105) [kNm]	6%	6%	18%	40%	11%	15%	1%	8%	6%	31%	1%	211%	6%	1%	8%	35%	58%
Q (105) [kN]	56%	209%	1%	19%	42%	9%	16%	9%	1%	33%	10%	61%	6%	21%	24%	56%	42%
N (105) [kN]	530%	46%	23%	15%	3%	21%	23%	42%	3%	3%	3%	3%	3%	3%	1%	0%	1%

STAGES/STAGES+TDMP

	1	2	3	4	5	6	7	8	9	10	11	12	13	14	15	16	17
u3 (105)[m]	80%	89%	45%	129%	76%	75%	48%	33%				83%	68%	96%	46%	44%	24%
u1 (105)[m]	28%	153%	25%	20%	49%	59%	28%	36%				28%	50%	41%	31%	31%	35%
M (105) [kNm]	1%	0%	7%	51%	2%	13%	0%	0%	18%	0%	15%	26%	3%	1%	3%	88%	11%
Q (105) [kN]	32%	30%	1%	5%	8%	13%	9%	2%	12%	1%	9%	21%	1%	2%	0%	28%	14%
N (105) [kN]	7%	9%	1%	90%	7%	2%	1%	14%	1%	1%	1%	1%	1%	1%	1%	0%	0%

The comparison of the results of three variants of modelling and calculation of the structure show differences in the magnitudes of displacements and the internal forces. Taking into account the time dependent material properties in general results increase in the

magnitude of all quantities. That increase is different at different structural elements.

Changes in vertical and horizontal displacements, bending moments, shear and axial forces when accounting for the construction stages and the TDMP of concrete are presented in the following tables.

Vertikal displacements (elastic)

day	1	2	3	4	5	6	7	8	9	10	11	12	13	14	15	16	17
0	-0,001	-0,003							0,000	0,000	0,000						
7	-0,002	-0,008							0,000	0,000	0,000						
35	-0,003	-0,008	0,000	-0,001	-0,004	-0,002			0,000	0,000	0,000	0,000	0,000	0,000			
42	-0,003	-0,007	0,000	-0,002	-0,009	-0,005			0,000	0,000	0,000	-0,001	-0,001	0,000			
70	-0,003	-0,007	-0,002	-0,001	-0,011	-0,007	-0,005	-0,002	0,000	0,000	0,000	-0,001	-0,002	-0,001	-0,002	-0,001	-0,001
77	-0,004	-0,009	-0,003	-0,001	-0,012	-0,007	-0,007	-0,003	0,000	0,000	0,000	-0,001	-0,002	-0,001	-0,003	-0,001	-0,002
105	-0,004	-0,011	-0,005	-0,001	-0,014	-0,009	-0,011	-0,005	0,000	0,000	0,000	-0,001	-0,003	-0,001	-0,005	-0,002	-0,004

Horizontal displacements (elastic)

day	1	2	3	4	5	6	7	8	9	10	11	12	13	14	15	16	17
0	0,000	0,000							0,000	0,000	0,000						
7	-0,001	-0,001							0,000	0,000	0,000						
35	0,000	-0,001	0,000	0,000	0,000	0,000			0,000	0,000	0,000	0,000	0,000	0,000			
42	0,000	-0,001	-0,001	-0,001	-0,001	-0,001			0,000	0,000	0,000	-0,001	-0,001	0,001			
70	0,000	-0,001	-0,001	-0,001	-0,001	-0,002	-0,001	-0,001	0,000	0,000	0,000	-0,001	-0,002	0,000	-0,002	-0,001	-0,001
77	0,000	-0,001	-0,002	-0,002	-0,002	-0,002	-0,002	-0,002	0,000	0,000	0,000	-0,001	-0,002	0,000	-0,003	-0,002	-0,002
105	0,000	-0,001	-0,002	-0,002	-0,003	-0,003	-0,003	-0,004	0,000	0,000	0,000	-0,002	-0,003	-0,001	-0,004	-0,003	-0,003

Bending moments

day	1	2	3	4	5	6	7	8	9	10	11	12	13	14	15	16	17
0	51,52	99,53							-17,89	-14,21	25,65						
7	102,83	198,76							-35,00	-28,63	50,73						
35	49,10	93,13	0,00	40,94	103,29	59,19			-14,17	-12,68	20,83	14,43	19,80	-43,64			
42	49,75	92,85	0,00	82,13	207,81	122,76			-14,47	-11,81	23,53	26,55	38,36	-85,11			
70	54,40	94,57	25,43	-6,06	131,89	115,59	103,91	49,38	-15,16	-10,23	24,02	-14,30	41,42	-55,70	42,35	-6,12	-10,23
77	76,90	134,65	22,14	12,35	178,09	158,36	102,53	47,86	-21,18	-14,55	27,24	-4,60	52,22	-78,05	41,91	-5,47	-9,81
105	91,52	157,90	30,25	3,01	214,06	182,97	151,94	69,62	-24,74	-15,84	30,93	-10,38	67,32	-96,46	63,49	-5,99	-13,92

Shear forces

day	1	2	3	4	5	6	7	8	9	10	11	12	13	14	15	16	17
0	2,49	-7,05							-16,43	-12,48	28,89						
7	0,90	-9,92							-32,19	-24,97	57,16						
35	0,85	-7,04	0,00	-2,68	-11,42	53,41			-13,36	-10,58	23,95	-10,51	-13,51	24,06			
42	-1,70	-6,41	3,91	0,92	-19,37	98,16			-13,80	-9,71	19,99	-17,13	-24,64	41,77			
70	-0,49	-8,44	103,92	-22,46	-24,65	40,18	-7,34	8,50	-15,27	-8,75	19,31	3,71	-29,34	25,65	-6,72	-4,66	11,38
77	-3,45	-8,88	103,45	-26,78	-27,86	138,77	-6,91	7,85	-20,84	-11,59	32,70	-6,63	-39,12	45,80	-7,91	-5,01	12,92
105	-6,03	-9,61	150,64	-40,38	-33,25	208,89	-10,83	11,70	-24,41	-12,71	37,11	-8,41	-52,16	60,56	-13,23	-10,36	23,65

Axial forces

day	1	2	3	4	5	6	7	8	9	10	11	12	13	14	15	16	17
0	-16,43	-28,89							-79,09	-252,83	-107,31						
7	-30,68	-54,79							-150,43	-500,20	-207,09						
35	-2,86	0,06	0,00	-10,51	-24,02	-24,02			-211,31	-498,92	-214,52	-124,32	-241,50	-100,96			
42	3,33	18,25	0,00	-16,14	-39,64	-39,64			-335,80	-739,80	-314,15	-246,27	-485,56	-199,96			
70	-18,97	1,63	6,72	10,42	-14,27	-25,65	-6,72	-11,38	-336,31	-756,22	-271,45	-247,98	-498,74	-159,29	-97,64	-253,57	-65,31
77	-14,22	13,04	7,91	1,28	-32,82	-45,74	-7,91	-12,92	-435,26	-974,81	-370,57	-308,89	-608,18	-208,24	-97,21	-258,51	-64,67
105	-16,01	23,45	13,29	4,89	-36,91	-60,56	-13,29	-23,65	-555,22	-1225,64	-458,68	-404,88	-792,11	-265,96	-144,39	-383,06	-95,51

The graphic presentation of the results is not included in the present article due to its relatively large volume.

5 CONCLUSIONS

Taking into account the construction stages, they affect significantly the displacements and the internal forces of the structural elements. That influence is different on the different elements as well as on the separate internal forces in particular section. The differences depend also on the material type, the structural geometry, the type and sequence of loads' application and the climate, except the type and position of the particular element in consideration. The presented results of different ways of modelling and calculation of the structure show that the construction stages have a slight influence on the elements like end columns and short beams ($L < 10 \cdot h_{beem}$), no matter if the TDMP of concrete are taken into account or not. However for longer beams ($L > 10 \cdot h_{beem}$), or the column at the middle of the frame the results show significant

differences and the obtained displacements and internal forces are of bigger magnitude. There is the other group of elements as the transfer columns at the top storey where accounting for the construction stages results in decrease of the internal forces. The study of the example structure in the article show that construction stages including the time-dependent material properties shall be taken into account in the design. There are differences in the displacements and the internal forces in main structural elements that cannot be neglected.

It should be kept in mind that during the construction the structural response could result in displacements and internal forces of magnitudes that are higher than the ones the elements are designed for.

6 LITERATURE

- [34] SAP2000, Version 16.0.1, Computers and Structures Inc, 2013.
- [35] CEB-FIP Model Code (1990), Thomas Telford Services Ltd., 1993

SUMMARY

COMPUTER MODELLING OF STRUCTURES WITH ACCOUNT OF THE CONSTRUCTION STAGES AND THE TIME DEPENDENT MATERIAL PROPERTIES

Alexander TRAYKOV
Raina BOIADJIEVA

Numerical studies are performed on computer models taking into account the stages of construction and time dependent material properties defined in two forms. A 2D model of three storey two spans frame is created. The first form deals with material defined in the usual design practice way – without taking into account the time dependent properties of the concrete. The second form creep and shrinkage of the concrete are taken into account. Displacements and internal forces in specific elements and sections are reported. The influence of the time dependent material properties on the displacement and the internal forces in the main structural elements is tracked down.

The results corresponding to the two forms of material definition are compared together as well as with the results obtained by the usual design calculations. Conclusions on the influence of the concrete creep and shrinkage during the construction towards structural behaviour are made.

Key words: Computer model, 2D model, construction stages, creep and shrinkage of concrete

REZIME

NUMERIČKO MODELIRANJE KONSTRUKCIJA UZ UVOĐENJE FAZA GRAĐENJA I SVOJSTAVA MATERIJALA ZAVISNIH OD VREMENA

Alexander TRAYKOV
Raina BOIADJIEVA

Numeričke analize na matematičkim modelima, kojima se uvode faze građenja i svojstva materijala zavisnih od vremena, definisane su u dva oblika. Model je dvodimenzionalni (2D) troetažni i s dva raspona. Prvi oblik tretira materijal definisan u uobičajenoj formi za projektantsku praksu – bez uvođenja svojstava betona zavisnih od vremena. U drugom obliku uvode se u analizu skupljanje i tečenje betona. Prikazani su pomeranja i presečne sile u pojedinim elementima i presecima. Izloženi su rezultati uticaja vremenski zavisnih svojstava materijala na pomeranja i presečne sile primarnih konstrukcijskih elemenata.

Rezultati odgovarajući za dva oblika definicije materijala upoređeni su s rezultatima dobijenim uobičajenim proračunima pri projektovanju. Formulirani su odgovarajući zaključci o uticaju skupljanja i tečenja betona tokom izvođenja radova.

Ključne reči: proračunski model, 2D model, faze građenja, skupljanje i tečenje betona

VIŠEKRITERIJUMSKO VREDNOVANJE I IZBOR PROZORA

MULTICRITERIA EVALUATION AND WINDOW SELECTION

Jasmina DRAŽIĆ
Mirjana LABAN

ORIGINALNI NAUČNI RAD
ORIGINAL SCIENTIFIC PAPER
UDK: 674.21
doi: 10.5937/grmk1503037D

1 UVOD

U fazi projektovanja fasadnog platna, prozori i prozorski otvori svojim položajem, veličinom, oblikom, podelom, odnosom punim i transparentnim površinama, veoma utiču na njegov izgled, kao i na estetski doživljaj [2]. Poznato je da dobro projektovan i konstruisan prozor treba da zadovolji istovremeno više katkad i kontradiktornih funkcija: osvetljavanje, osunčanje, provetravanje, ali i zaštita od atmosferilija, sunca, vetra, toplote, buke, te vizuelna povezanost unutrašnjih prostora sa spoljašnjim prostorom, ali i zaštita od pogleda spolja. Da bi obezbedio osnovnu funkciju, prozor mora da zadovolji niz standarda kojima se ispunjavaju opšti i posebni tehnički uslovi za taj građevinski elemenat [1]. Prozor dolazi na mesto izgradnje objekta kao gotov elemenat, pa proizvođač atestima dokazuje njegove karakteristike, a pravilnom ugradnjom i završnim obradama, izvođač radova treba da obezbedi zahtevani kvalitet projektovanog elementa.

U početku su se za proizvodnju prozora koristili isključivo prirodni materijali, razne vrste drveta (čamovina, hrast, trešnja i dr.), dok danas proizvodnja prozora uključuje i primenu drugih materijala (npr. PVC, aluminijuma), kao i njihovu kombinaciju u okviru jednog elementa. Svaki od ovih materijala ima različita tehnička svojstva, pa kada se upoređuju i vrednuju karakteristike prozora proizvedenih od ovih materijala, svaki od njih ima i prednosti i nedostataka [12]. Za zastakljivanje prozora mogu se koristiti različiti tipovi stakala [2]. Primena dvostrukog ili trostrukog izolacijskog stakla male emisije tzv. Low-e stakla, znatno smanjuje koefici-

Jasmina Dražić, dr, Fakultet tehničkih nauka
Trg Dositeja Obradovića 6, 21000 Novi Sad
e-mail: dramina@uns.ac.rs
Mirjana Laban, dr, Fakultet tehničkih nauka
Trg Dositeja Obradovića 6, 21000 Novi Sad
e-mail: mirjana.laban@core-ns.org

1 INTRODUCTION

When designing a façade, windows and window openings display a great impact on the appearance and aesthetics with their position, size, form, division, as well as the ratio between full and transparent areas [2]. It is well known that a well designed and constructed window has to satisfy a number of functions simultaneously, which can be contradictory at times. These include lightening, shading, airing, protection from weathering, sun, wind, heat, noise, as well as visual connection between inner and outer space, together with the protection from the views from outside. In order to provide its fundamental function, a window has to satisfy a set of standards that ensure general and specific technical conditions for that construction element [1]. The window arrives to the building site as a finished product; hence, the manufacturer provides attestations to prove the characteristics. On the other hand, with the proper installation and processing, the contractor has to provide the set quality of the designed element.

At the beginnings, exclusively natural materials, like various types of timber (fir, oak, cherry, etc.), were used for window manufacturing; today, however, window manufacture includes the application of other materials as well, such as PVC, aluminium, as well as their combination within an element. Each of these materials possesses diverse technical properties, hence, when windows made of different materials are compared, each one can present certain advantages and drawbacks [12]. Different types of glass can be utilized for glazing the windows [2]. The application of double or triple pane

Jasmina Dražić, PhD, Faculty of Technical Sciences
Trg Dositeja Obradovića 6, 21000 Novi Sad
e-mail: dramina@uns.ac.rs
Mirjana Laban, PhD, Faculty of Technical Sciences
Trg Dositeja Obradovića 6, 21000 Novi Sad
e-mail: mirjana.laban@core-ns.org

jent prolaza toplote, pa doprinosi rešenju problema energetske gubitaka u objektu. Možemo konstatovati da je osnovna funkcija prozora ostala ista kroz vreme, ali su vidna poboljšanja u estetskom smislu i tehničkim karakteristikama, kojima se postiže adekvatan nivo zaštite i obezbeđuje racionalno korišćenje energije za zagrevanje i hlađenje [11].

Spoj i kombinacija više materijala u okviru prozora (drvo, PVC, aluminijum, za doprozornik i prozorsko krilo, dvostruko, trostruko termoizolaciono staklo, staklo, s Low-e premazom ili bez njega), formira građevinske elemente različitih tehničkih karakteristika. Prateći trend razvoja, građevinska industrija nudi širok asortiman različitih elemenata, pa otvara problem izbora najpovoljnijeg. Kako je u analizu izbora prozora potrebno uvrstiti veći broj raznorodnih pokazatelja (pokazatelji u pogledu energetske efikasnosti, pokazatelji kvaliteta boravka u objektu, pokazatelji efektivnosti gradnje, trajnost, ekološki faktor itd.), rešenje problema izbora prozora podrazumeva višekriterijumsko odlučivanje. Naime, potrebno je uskladiti projektne i izvođačke zahteve, te zahteve korisnika, s karakteristikama prozora i iz toga izvući maksimum, a pravilnim odabirom kriterijuma objediniti bitne faktore za ocenu optimalnog rešenja.

U radu je predložena metodologija višekriterijumskog vrednovanja prozora, algoritam toka odlučivanja, kriterijumi, model i metoda optimizacije. Variranjem četiri tipa prozora (materijala za doprozornik i prozorsko krilo) s različitim zastakljenjem (dvoslojno i troslojno staklo), izabrano je optimalno rešenje.

2 VIŠEKRI TERIJUMSKO ODLUČIVANJE PRI IZBORU PROZORA

Uglavnom primenjivani metod vrednovanja u građevinarstvu zasnivao se na upoređivanju varijanti na osnovu jednog - najčešće finansijsko-ekonomskog - kriterijuma, bez potrebe uvođenja i vrednovanja i ostalih mogućih aspekata. Posledice ovakvog pristupa jesu subjektivno, iskustveno i nedovoljno dokumentovano obrazloženje rezultata i konačne odluke. To je iniciralo da se prilikom izbora najpovoljnijeg tipa prozora predloži metodologija vrednovanja i odlučivanja koja će obuhvatiti, osim finansijsko-ekonomskih kriterijuma, tehničko-tehnološke, ekološke i druge kriterijume.

Kompleksan proces optimizacije obuhvata:

- generisanje skupa mogućih varijantnih rešenja;
- vrednovanje varijanti prema usvojenim kriterijumima;
- rangiranje varijantnih rešenja;
- analizu i izbor najpovoljnije varijante.

Najpovoljnija varijanta tada predstavlja optimalno rešenje optimizacionog zadatka odnosno kompromis između želja (kriterijuma) i mogućnosti (ograničenja). Kriterijum se izražava kriterijumskom funkcijom koja za najpovoljniju varijantu (rešenje) treba da dostigne globalni ekstremum s obzirom na ograničenja, kao uslova za mogućnost postizanja cilja optimizacije [4].

Za većinu problema koji se pojavljuju i rešavaju u inženjerskoj praksi teško je ili čak nemoguće formulisati sveobuhvatni matematički model optimizacije, pa se primenjuje „prilaz diskretnih modela” i projektuju varijantna rešenja [5]. U skladu s definisanim ciljem - ostvariti ekstremne vrednosti usvojenih kriterijuma,

insulated glass of low emissivity, i.e. low-E glass, significantly reduces the heat loss coefficient, thus contributing to the solution of energy losses in an object. It can be stated that the main function of windows has remained the same over time, though the evident improvements in the aesthetic sense and technical properties, leading to an adequate level of protection and providing the rational energy usage for heating and cooling, have been beneficial [11].

The joining and combination of several materials within a window (timber, PVC, and aluminium for the window frame and sash; double and triple pane thermal insulated glass, glass with or without the low-E coating for glazing) forms the structural element with diverse technical characteristics. Following the development trend, the construction industry offers a wide range of different elements, thus opening the problem for selecting the most suitable one. Since the analysis of window selection requires a greater number of diverse indicators (indicators related to energy efficiency, indicators related to the living quality in the object, indicators of the construction efficiency, durability, ecological factor, etc.), the solution for the window selection implies a multicriteria decision making. Namely, it is necessary to coordinate the demands by the designer, the contractor and the user with window characteristics and seize the maximum from the entire project, while consolidating the important factors for evaluating the optimal solution with the proper criteria selection.

The paper proposes the methodology for multicriteria window evaluation, the decision flow algorithm, as well as the criteria, model and methods for optimization. The variations in four window types (materials for frames and sash) with diverse glazing (double and triple pane glass) lead towards the selection of the optimal solution.

2 MULTICRITERIA DECISION-MAKING IN WINDOW SELECTION

The most applied evaluation method in construction is based on comparing the variation based on one, typically financial-economic criterion, without the need to introduce and evaluate other possible aspects. The consequences of this approach are subjective, inexperienced and under-documented explanations of the results and final decisions. This situation has initiated the procedure to propose the methodology of evaluation and decision-making into the procedure of selecting the most suitable window type that will, apart from the financial-economical criterion, include technical-technological, ecological, and other criteria as well.

The complex process of optimization includes the following:

- Generating the set of possible variation solutions,
- Evaluating the variations according to the set criteria,
- Ranking the variation solutions, and
- Analysing and selecting the most suitable variation.

The most suitable solution in that case presents the optimal solution of optimization task, i.e. a compromise between the demands (criteria) and possibilities (limitations). The criteria are expressed by criterion functions that should achieve the global extreme for the most suitable variation (solution) regarding the limitations that condition the possibilities for achieving the optimization

postupak rešavanja optimizacionog zadatka odvija se u više koraka i na više nivoa odlučivanja. Algoritam toka višekriterijumskog odlučivanja pri izboru prozora prikazan je na slici 1.

Prilikom višekriterijumskog odlučivanja, fazi generisanja mogućih varijantnih rešenja prozora prethodi analiza opštih i posebnih uslova. Opšti i posebni uslovi koje prozor treba da zadovolji generišu moguća varijantna rešenja, pri čemu svako varijantno rešenje opisuje različiti parametri u pogledu termoizolacionih karakteristika, zvučne izolacije, troškova i vremena ugradnje, trajnosti ugrađenog elementa i ekologije.

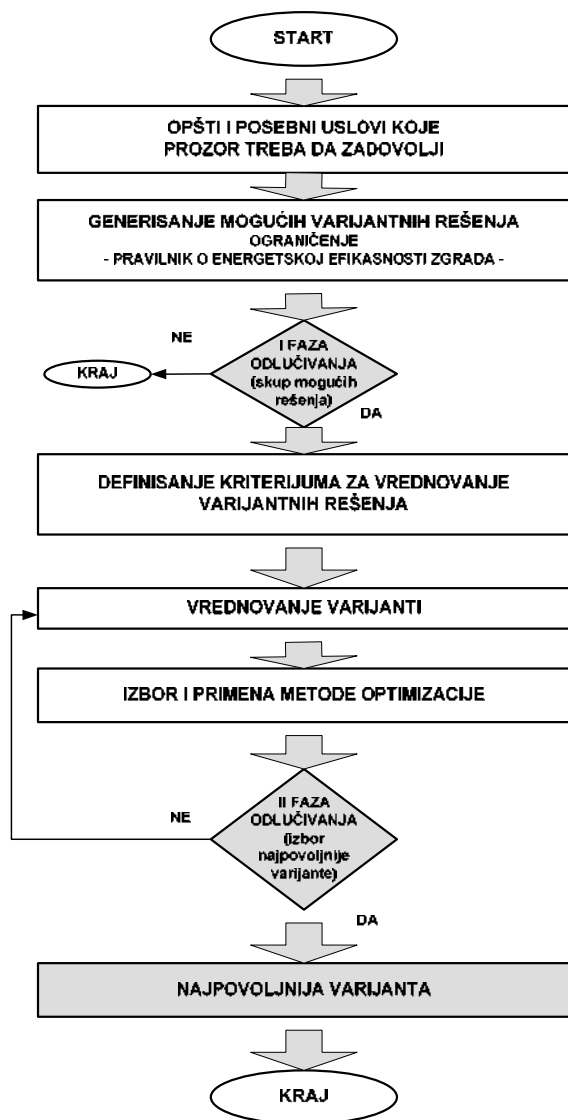

Slika 1. Algoritam toka višekriterijumskog odlučivanja pri izboru prozora

Skup mogućih rešenja generira se u skladu s projektnim zahtevima, zadatim Standardima za materijale i kompletne elemente i ograničenjima, a koje propisuje Pravilnik o energetskej efikasnosti zgrada za ovaj građevinski element.

U prvoj fazi odlučivanja, eliminišu se ona rešenja čiji parametri ne zadovoljavaju unapred postavljena ograničenja. U skladu s definisanim kriterijumima,

goals [4].

For most problems occurring and being solved in the engineering practice, it is hard or sometimes impossible to formulate the overall mathematical optimization model; hence, one has to apply the “discrete model approach” and design the variation solutions [5]. In accordance with the defined objective, which is to accomplish the extreme values of the set criteria, the procedure for solving the optimization task is undertaken in several steps and several decision levels. The algorithm of multicriteria decision-making flow in selecting the window is presented in Fig. 1.

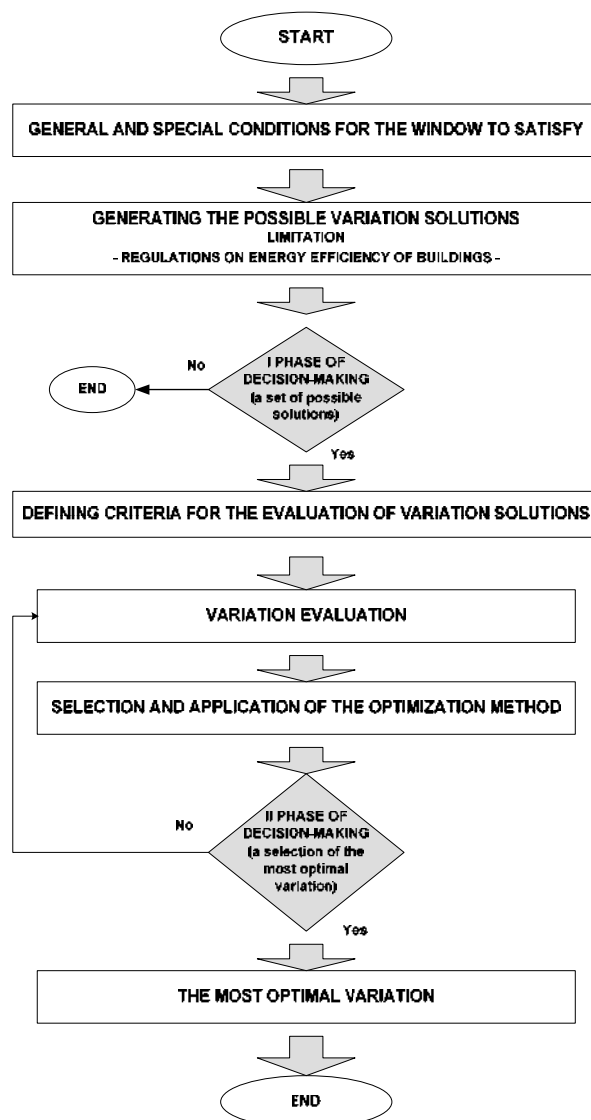

Fig. 1. Algorithm for multicriteria decision-making flow in window selection

In the process of multicriteria decision-making, the analysis of general and specific conditions precedes the phase of generating the possible variation solutions for windows. General and special conditions for the window to satisfy generate the possible variation solutions, where each variation solution is described by diverse parameters related to thermal insulation properties, sound insulation, costs and construction time, durability

varijante se vrednuju i rangiraju. Problem izbora najpovoljnijeg tipa prozora sadrži više varijantnih rešenja i više kriterijuma na osnovu kojih se varijante vrednuju, a kako su kriterijumske funkcije različite po karakteru, numeričkim vrednostima i jedinicama, bez primene adekvatne metode - nemoguće je doći do rešenja.

Za rešavanje problema izbora najpovoljnijeg tipa prozora predloženo je višekriterijumsko odlučivanje koje obezbeđuje viši nivo objektivnosti prilikom donošenja odluka i metoda višekriterijumske optimizacije (VKO). Rezultat vrednovanja jeste rang-lista rešenja, koja pruža mogućnost da se usvoji konačno rešenje koje ispunjava zadate uslove u skladu s realnim ograničenjima. Primenom adekvatne metode višekriterijumske optimizacije, uvođenjem težinskih koeficijenata, moguće je dobiti više izlaza, rang-lista varijantnih rešenja i izabrati jedno konačno (optimalno) rešenje u drugoj fazi odlučivanja.

Ovakav pristup i tok aktivnosti u predloženoj metodologiji omogućava da odlučivanje i izbor najpovoljnijeg tipa prozora budu objektivni, dovoljno dokumentovani, s prihvatljivim stupnjem subjektivnosti, uz argumentovano obrazloženje svih rezultata.

of the element, and ecology. The set of possible solutions is generated in accordance with the project demands prescribed by the Standards for Materials and Complete Elements and in accordance with the limitations prescribed by the Regulations on Energy Efficiency of Buildings for this construction material.

In the first phase of decision-making, the solutions whose parameters fail to satisfy preset limitations are eliminated. In accordance with the defined criteria, variations are evaluated and ranked. The problem of selecting the most suitable window type contains several variation solutions and several criteria used to evaluate these variations. Since the criterion functions are diverse by character, numerical values and units, it is impossible to achieve the solution without the application of an adequate method.

For solving the problem of selecting the most optimal window type, multicriteria decision-making is proposed, since it provides the higher level of objectivity in the process of decision-making, together with the multicriteria optimization method. The evaluation result is the rank list of solutions that provides the possibility to adopt the final solution that fulfils the set conditions in accordance with real limitations. On applying an adequate method of multicriteria optimization by introducing the weight coefficients, it is possible to obtain several output results, then rank those variation solutions, and thus select one final (optimal) solution in the second decision-making phase.

This approach and the flow of activities in the proposed methodology enable the decision-making process and selection of the most optimal type of window to be objective, adequately documented with the acceptable degree of subjectivity, and argumentatively explained.

3 MATEMATIČKA FORMULACIJA PROCESA OPTIMIZACIJE

Metodologija višekriterijumskog odlučivanja pri izboru prozora bazirana je na početnoj matrici odlučivanja tipa $N \times J$, formiranoj od N -kriterijuma i J -varijanti. Matrica je prikazana u tabeli 1.

3 MATHEMATICAL FORMULATION OF THE OPTIMIZATION PROCESS

The methodology of multicriteria decision-making in selecting the window is based on the initial decision matrix type $N \times J$, formed from N -criteria and J -variations. The matrix is presented in Table 1.

Tabela 1. Početna matrica odlučivanja
Table 1. Initial decision-making matrix

	V	a	r	i	a	t	i	o	n
		V_1	V_2		V_j
K/C									
r	K_1	f_{11}	f_{12}				f_{1j}
i	K_2	f_{21}							
t							
e							
r							
i	K_N	f_{1n}							f_{nj}
a									

gde su:

V_j - varijante
 K_i - kriterijumi
 f_{ij} - vrednost kriterijumske funkcije

where:

V_j - variations
 K_i - criteria
 f_{ij} - values of criterion functions

3.1 Kriterijumi optimizacije

Formiranje matrice odlučivanja podrazumeva definisanje kriterijuma za vrednovanje varijantnih rešenja prozora. Da bi se obuhvatili bitni aspekti relevantni za izbor najpovoljnijeg tipa prozora, u model optimizacije uvršteni su raznorodni kriterijumi - kvantitativni, kvalitativni, tehničko-tehnološkog, ekonomsko-finansijskog i ekološkog karaktera. Definisani kriterijumi optimizacije jesu:

- f_1 - koeficijent prolaza toplote prozora;
- f_2 - pokazatelj svetlosne propustljivosti stakla;
- f_3 - pokazatelj zvučne izolacije prozora;
- f_4 - finansijski pokazatelj (cena prozora);
- f_5 - vreme ugradnje prozora;
- f_6 - pokazatelj trajnosti;
- f_7 - pokazatelj ekologije

Položaj prozora u spoljanjem omotaču zgrade uzrokuje gubitke toplotne energije, pa usmerava izbor u pravcu energetski efikasnog elementa. Termičke karakteristike prozora vezuju se za standard SRPS EN ISO 10077-1 *Toplotne performanse prozora, vrata i kapaka - proračun koeficijenata prolaza toplote - deo 1 opšte* [7] i standard SRPS EN ISO 10077-2 *Toplotne performanse prozora, vrata i kapaka - proračun koeficijenata prolaza toplote - deo 2 numerička metoda za okvir* [8]. Termičke karakteristike prozora definiše koeficijent prolaza toplote U_w [W/(m²xK)], koji zavisi od koeficijenta toplotne provodljivosti okvira U_f , i koeficijenta toplotne provodljivosti stakla U_g . Proračunska vrednost koeficijenta prolaza toplote prozora, prema Pravilniku o energetskoj efikasnosti zgrada, mora da bude manja od vrednosti $U_{wmax}=1,5$ [W/(m²xK)] (ili jednaka s njom [6]). U skladu s kriterijumskom funkcijom f_1 , prednost imaju tipovi prozora s manjim vrednostima ove funkcije, jer obezbeđuju bolje toplotne performanse objekta i doprinose ukupnoj energetskoj efikasnosti objekta.

Prozori sa svojim staklenim delom primarni su elementi prirodnog osvetljenja enterijera i njegovog funkcionalnog korišćenja. Prirodno osvetljenje je najkvalitetniji izvor svetlosti u enterijeru i treba da određuje i arhitektonski i organizacioni koncept objekta. Cilj energetski efikasne gradnje, dakle, jeste smanjenje energetskih gubitaka na staklenim površinama, ali i težnja da se ostvari što bolje prirodno osvetljenje. Ovakav pristup u postupak vrednovanja prozora uvrstio je kriterijumsku funkciju f_2 - pokazatelj svetlosne propustljivosti stakla. Predloženi oblik kriterijumske funkcije f_2 , minimalnim vrednostima obezbeđuje veću svetlosnu propustljivost:

$$f_2 = P_s = 1 - p \quad (1)$$

gde je:

p - svetlosna propustljivost stakla

Prozor - kao građevinski elemenat - treba da obezbedi i adekvatnu zvučnu izolaciju. U zavisnosti od tipa objekta i unutrašnjih prostorija, dozvoljeni nivo buke se menja. Zvučnu izolaciju tretira grupa standarda SRPS ISO 140 *Akustika-merenje zvučne izolacije u zgradama i zvučne izolacije građevinskih elemenata* [9] i standard SRPS EN ISO 14351-1 *Prozori i vrata, standard za*

3.1 Optimization criteria

Forming the decision matrix implies definitions of criteria for evaluating the variation window solutions. In order to enclose the important aspects relevant for the selection of the most optimal window type, the model includes diverse criteria of quantitative, qualitative, technical-technological, economic-financial and ecological character. The defined optimization criteria are as follows:

- f_1 – coefficient of the window heat transfer
- f_2 – indicator of the light transparency of glass
- f_3 – indicator of the sound insulation of the window
- f_4 – financial indicator (price of the window)
- f_5 – time for window installation
- f_6 – durability indicator
- f_7 – ecological indicator

The position of the window in the outer façade of the building makes it responsible for heat energy losses, hence directing the selection towards the energy efficient element. Thermal window properties are related to the standard SRPS EN ISO 10077-1 *Heat performances of windows, doors and shutters – calculation of heat transfer coefficient – section 1 general* [7] and the standard SRPS EN ISO 10077-2 *Heat performances of windows, doors and shutters – calculation of heat transfer coefficient – section 2 numerical method for frames* [8]. Thermal properties of windows are defined by the heat transfer coefficient U_w [W/(m²xK)], which depends on the frame heat conductivity coefficient U_f , and the glass heat conductivity coefficient U_g . The calculation value of the window heat transfer coefficient, according to the Regulation of Energy Efficiency of Buildings, has to be lower (or equal) to the value $U_{wmax} = 1.5$ [W/(m²xK)] [6]. In accordance with the criterion function f_1 , the advantage is provided for the window types with lower values of this function, since they provide better heat performances of the object and contribute to the total energy efficiency of the structure.

With the glass area, windows present the primary element of natural lightening of interior and its functional usage. Natural light is the most qualitative source of light in the interior and it should determine both the architectural and organizational concept of an object. An energy efficient building has the objective to decrease energy losses on glass surfaces, as well as the demand to provide as good natural lightening as possible. This approach in the evaluation procedure for windows demands the criterion function f_2 – indicator of the light transparency of glass. The proposed form of the criterion function f_2 provides greater light conductivity with minimal values:

where:

p – light conductivity of glass

The window as a construction element should provide adequate sound insulation as well. Depending on the type of structure and interior spaces, the permitted level of noise is altered. Sound insulation is treated by a group of standards SRPS ISO 140 *Acoustics – measuring the sound insulation in buildings and sound insulation of construction elements* [9] and

proizvod, karakteristike i performanse – deo 1 [10]. U zavisnosti od nivoa buke, prozori se svrstavaju u određene klase zvučne izolacije. Zvučna izolacija prozora označava se sa R_w , a izražava u dB. Vrednost zvučne izolacije prozora uslovljena je karakteristikama ugrađenih materijala, zvučnom izolativnošću stakla, zvučnom izolacijom doprozornika, okvira prozorskih krila, ali i zvučnom izolacijom spojeva i preklopa. U skladu s minimizacijom vektorske kriterijumske funkcije, definisana je kriterijumska funkcija f_3 , pokazatelj zvučne izolacije prozora u obliku:

$$f_3 = P_z = 1/R_w \quad (2)$$

gde je:

R_w – zvučna izolacija prozora.

Pri vrednovanju varijantnih rešenja prozora, prednost se daje manjim vrednostima ovog pokazatelja (kriterijumske funkcije f_3), jer one obezbeđuju veći nivo zvučne zaštite.

Da bi se obuhvatili pokazatelji koji su bitni u fazi izvođenja objekta i koji direktno utiču na efektivnost izgradnje, ukupne troškove i rok, u model optimizacije uvrštene su kriterijumske funkcije f_4 i f_5 . Kriterijumska funkcija f_4 jeste ekonomsko-finansijskog karaktera i predstavlja troškove nabavke prozora (tržišnu cenu), dok se kriterijumska funkcija f_5 , odnosi na vreme ugradnje prozora i izračunava se na bazi adekvatnih normativa i standarda rada u građevinarstvu [3]. Pri vrednovanju, prednost ima ona varijanta prozora u kojoj su vrednosti obe kriterijumske funkcije minimalne.

Vek trajanja prozora, ako se adekvatno održava, zavisi od karakteristika materijala, završne obrade, kao i od atmosferskih uticaja kojima je izložen. Kriterijumsku funkciju f_6 , definiše pokazatelj trajnosti prozora u obliku:

$$f_6 = P_t = T_{max}/T_i \quad (3)$$

gde su:

T_{max} – maksimalna trajnost prozora u okviru razmatranih varijanti

T_i – pojedinačna trajnost prozora

Manja vrednost ovog pokazatelja odgovara tipu prozora koji ima veću trajnost.

Prozori su vrednovani i iz ekološkog aspekta, uvođenjem još jedne kriterijumske funkcije f_7 – pokazatelja ekologije. Mogućnost reciklaže materijala od kog su proizvedeni doprozornik i okvir prozorskog krila, data je opisnim kriterijumom [13].

the standard SRPS EN ISO 14351-1 *Windows and doors, standard for the product, characteristics and performances – part 1* [10]. Depending on the noise level, windows are divided into certain classes of sound insulation. Window sound insulation is denoted by R_w and measured in dB. The value of the window sound insulation is conditioned by the properties of the built-in materials, sound insulation of glass, sound insulation of frames, window casements, and sound insulation of joints and spacers. In accordance with the minimization of the vector criterion function, the criterion function f_3 - the indicator of the sound insulation - is defined in the following expression:

where:

R_w – sound insulation of the window.

In evaluating the variation solutions for the window, the advantage is provided for the smaller values of this indicator (criterion function f_3), since these provide higher level of sound protection.

In order to include the indicators that are relevant in the phase of object construction and which directly influence construction efficiency, overall costs and deadlines, criterion functions f_4 and f_5 are included into the optimization model. The criterion function f_4 has the economic-financial character and it presents the costs of obtaining the windows (market price), while the criterion function f_5 refers to the time necessary for installing the windows and it is calculated on the basis of adequate normative and working standards in construction [3]. In the evaluation process, the advantage is provided for the window variation where the values of both criterion functions are minimal.

Window durability, if maintained adequately, depends on the material properties, finishing, as well as the weathering. The criterion function f_6 is defined as the indicator of the window durability in the following expression:

where:

T_{max} - maximal window durability within the observed variations,

T_i - individual window durability.

Lower value of this indicator refers to more durable window type.

The windows can be evaluated from ecological aspect as well, by introducing another criterion function f_7 , the ecological indicator. The possibility to recycle the material from which the frames and sashes are manufactured is presented by the descriptive criterion [13].

Tabela 2. Opisni kriterijum – ekologija (održivi razvoj)

ekološki kriterijum (opis)			
PROZOR -drvo-	PROZOR -PVC	PROZOR -aluminijum-	PROZOR -drvo-aluminijum-
Drveni prozori su potpuno u skladu sa ekološkim zahtevima zbog mogućnosti recikliranja. Korišćenjem drveta pospešujemo održivi razvoj zemlje.	Ima mogućnost recikliranja, ali se primarno dobija iz neobnovljivih izvora.	Ima mogućnost recikliranja, ali se primarno dobija iz neobnovljivih izvora.	Kombinacija dva materijala, pa sublimira u sebi ekološki aspekt oba.

Table 2. Descriptive criterion – ecology (sustainable development)

Ecological criterion (description)			
WINDOW - timber-	WINDOW -PVC	WINDOW -aluminium-	WINDOW -timber-aluminium-
Timber windows are completely in accordance with ecological demands and the possibilities for recycling. Using wood, one increases the sustainable development of the country.	It has the possibility for recycling, though it is primarily produced from non-renewable sources.	It has the possibility for recycling, though it is primarily produced from non-renewable sources.	A combination of two materials, hence combining ecological aspects of both.

Da bi se pri vrednovanju prozora obuhvatio i ekološki aspekt, pre svega mogućnost recikliranja, predložen je način kvantifikacije ekološkog kriterijuma – rangiranjem.

In order to include the ecological aspect into evaluation, which primarily refers to the possibilities for recycling, there is a proposition for the manner of quantifying the ecological criterion by ranking.

Tabela 3. Pokazatelj ekologije
Table 3. Ecological indicator

PROZOR / WINDOW - drvo / timber-	PROZOR / WINDOW -PVC-	PROZOR / WINDOW - aluminijum / aluminium -	PROZOR / WINDOW - drvo-aluminijum - - timber-aluminium -
rangiranje / ranking			
1.0	2.0	2.0	1.5

Ulazni podaci za optimizaciju (početna matrica odlučivanja) jesu vrednosti pojedinačnih kriterijumskih funkcija ($f_1, f_2, f_3, f_4, f_5, f_6, f_7$) za svaku varijantu. Model optimizacije za izbor najpovoljnijeg tipa prozora minimizira sve kriterijumske funkcije i definisan je u obliku:

$$\min F(x) = \min (f_1, f_2, f_3, f_4, f_5, f_6, f_7) \quad (4)$$

Kako su vrednosti pojedinačnih kriterijumskih funkcija date u različitim jedinicama i rasponima numeričkih vrednosti, sprovodi se normalizacija početne matrice odlučivanja. Analizom zahteva u problemu i mogućnosti metoda višekriterijumske optimizacije, za izbor optimalnog tipa prozora, predložene su metoda kompromisnog programiranja i metoda kompromisnog rangiranja alternativnih rešenja [4,5].

The input data for the optimization (the initial decision matrix) are the values of individual criterion functions ($f_1, f_2, f_3, f_4, f_5, f_6, f_7$) for every variation. The optimization model for selecting the most optimal window type for all criterion functions is defined in the following expression:

Since the values of individual criterion functions are presented in various units and ranges of numerical values, the normalization of the initial decision matrix has to be organized. After analyzing the demands in the problem and the possibilities of the multicriteria optimization method, the compromise programming method and compromise ranking method of alternative solutions are proposed for selecting the optimal type of the window [4, 5].

3.2 Izabrana metoda višekriterijumske optimizacije

Osnovna karakteristika **metode kompromisnog programiranja** jeste da se rešenje zadatka višekriterijumske optimizacije određuje minimizacijom odstupanja od idealne tačke, prema usvojenoj meri rastojanja, uključujući sve kriterijume. Kao mera rastojanja od idealne tačke u ovoj metodi koristi se Lp metrika, koja predstavlja rastojanje između idealne tačke F^* i tačke $F(x)$ u prostoru kriterijumskih funkcija. Rešenje kojim se postiže minimum funkcije kompromisnog programiranja naziva se kompromisnim rešenjem problema VKO s parametrom p.

Parametar p koji se javlja u izrazu Lp ima ulogu balansirajućeg faktora između ukupne korisnosti i maksimalnog individualnog odstupanja. Malo p koristi se

3.2 The selected method for multicriteria optimization

The main characteristic of the **compromise programming method** is that the solution to the multicriteria optimization task is determined by minimizing the deviations from the ideal point, according to the adopted interval measure, including all criteria. As a deviation measure from the ideal point, the method utilizes the Lp metrics that represents the interval between the ideal point F^* and the point $F(x)$ in the area of criterion functions. The solution to achieve the minimum of the compromise programming function is referred to as the compromise solution of the multicriteria optimization problem with the parameter p.

The parameter p occurring in the expression "Lp" has

kada grupna korist ima prednost nad pojedinačnim (individualnim) odstupanjima. Povećanjem parametra p , smanjuje se ukupna korist, ali se smanjuje i maksimalno pojedinačno odstupanje od najbolje varijante. Izborom parametra p , usvaja se strategija postizanja kompromisa u višekriterijumskoj optimizaciji:

- $p = 1$ rešenje je najbolje po svim kriterijumima posmatranim zajedno;
- $p = 2$ rešenje je geometrijski najbliže idealnoj tački;
- $p = \infty$ prioritet je dat kriterijumu s najvećim odstupanjima.

Donosilac odluke može zadati ili menjati tokom rešavanja zadatka VKO težine pojedinih kriterijuma. Ovo se postiže uvođenjem težinskih koeficijenata. Prilikom rešavanja zadatka VKO u prvom prolazu, određuju se kompromisna rešenja za različite vrednosti parametara $p = 1, 2, \infty$, pod uslovom da sve kriterijumske funkcije imaju iste težinske koeficijente. Analizom ovih rezultata, donosilac odluke može odlučiti da li i kakve težinske koeficijente da zadaje za sledeći prolaz. Cilj je da se uvede „težina“ pojedinih kriterijuma i da se ponovnim rešenjem zadatka kompromisnog programiranja ispita osetljivost rešenja u odnosu na težinske koeficijente.

Višekriterijumsko kompromisno rangiranje varijantnih rešenja primenjuje se kada je potrebno odrediti redosled planiranih alternativnih rešenja na osnovu datih mera dobrote ili kriterijuma f_1, f_2, \dots, f_n . Jedini uslov koji treba da bude ispunjen jeste da je svaka varijanta vrednovana po svim kriterijumima iz datog skupa. Iterativno kompromisno rangiranje, kao metoda za višekriterijumsko rangiranje alternativnih rešenja, razvijeno je na osnovu elementa iz metode kompromisnog programiranja.

Polazi se od „graničnih“ formi L_p metrike, za $p = 1$ i za $p = \infty$.

$$S_j = \sum (f_i^* - f_{ij}) / (f_i^* - f_i^-), \quad (\text{za } p=1)$$

$$R_j = \max (f_i^* - f_{ij}) / (f_i^* - f_i^-), \quad (\text{za } p=\infty)$$

gde je $f_i^* = \max f_{ij}$ i $f_i^- = \min f_{ij}$ $i = 1, \dots, n$

$$S^* = \min_j S_j \quad \text{i} \quad R^* = \min_j R_j$$

Konačna rang-lista određuje se pomoću mere Q_j :

$$Q_j = v_1(S_j - S^*) / (S^- - S^*) + v_2(R_j - R^*) / (R^- - R^*)$$

Metoda omogućava da se zadaju i težine strategija odlučivanja v_1 i v_2 , $v_2 = 1 - v_1$

Pri tome;

- ako je $v_1 > v_2$: daje se prednost zadovoljenju većine kriterijuma, i ne vodi se računa o tome da jedan od kriterijuma može biti potpuno nezadovoljen;
- ako je $v_2 > v_1$: ne dopušta se potpuno nezadovoljenje bilo kog kriterijuma.

Primenom izabrane metode, dobija se rang-lista ili redosled varijantnih rešenja, za slučaj istih i različitih težinskih koeficijenata, odnosno donosi se konačna odluka o izboru jednog varijantnog rešenja.

the role of the balancing factor between the overall benefit and the maximal individual deviation. Small “ p ” is utilized when the group benefit has the advantage over the individual deviation. By increasing the parameter p , the overall benefit is decreasing; likewise, the maximal individual deviation from the best variation is also decreasing. By selecting the parameter p , the strategy of achieving a compromise in multicriteria optimization is adopted, as follows:

- $p = 1$ – The solution is the best according to all criteria regarded together;
- $p = 2$ – The solution is geometrically closest to the ideal point; and
- $p = \infty$ – The priority is attributed to the criterion with the largest deviations.

Decision maker can set or alter the weight of individual criteria during the process of solving the multicriteria optimization task. It is achieved by introducing weight coefficients. While solving the multicriteria optimization task in the first iteration, the compromise solutions for diverse values of the parameter $p = 1, 2, \infty$ are determined, under the condition that all criterion functions have the same weight coefficients. By analysing these results, the decision maker can determine whether to set weight coefficients, and which ones to set for the next iteration. The objective is to introduce the “weight” of individual criteria and interrogate the sensitivity of the solution in relation to weight coefficients by re-evaluating the solution of the compromise programming task.

Multicriteria compromise ranking of variation solutions is applied when it is necessary to determine the order of planned alternative solutions based on the set measures of wellness or the criteria f_1, f_2, \dots, f_n . The only condition to be fulfilled is that each variation is evaluated by all criteria from the provided set. Iterative compromise ranking, as a method for multicriteria ranking of alternative solutions, is developed on the basis of elements from the compromise programming method.

The starting points are the “limit” forms of L_p metrics, for $p = 1$ and for $p = \infty$.

$$S_j = \sum (f_i^* - f_{ij}) / (f_i^* - f_i^-), \quad (\text{for } p=1)$$

$$R_j = \max (f_i^* - f_{ij}) / (f_i^* - f_i^-), \quad (\text{for } p=\infty)$$

where $f_i^* = \max f_{ij}$ and $f_i^- = \min f_{ij}$ $i = 1, \dots, n$

$$S^* = \min_j S_j \quad \text{and} \quad R^* = \min_j R_j$$

The final rank list is determined utilizing the measure Q_j :

$$Q_j = v_1(S_j - S^*) / (S^- - S^*) + v_2(R_j - R^*) / (R^- - R^*)$$

The method enables specifying the weights of the decision making strategies v_1 and v_2 , $v_2 = 1 - v_1$ as well.

Thereby:

- If $v_1 > v_2$: the advantage is conferred to satisfying the most criteria, not taking into consideration whether one of the criteria can be completely unsatisfied, and
- If $v_2 > v_1$: the complete dissatisfaction of any criteria is not permitted.

4 METODOLOGIJA VIŠEKRIJUMSKOG ODLUČIVANJA – PRIMENA

Predložena metodologija višekriterijumskog odlučivanja, verifikovana je na primeru izbora najpovoljnijeg tipa prozora (optimalno rešenje). Vrednovani su:

- drveni prozor;
- PVC prozor;
- aluminijumski prozor;
- prozor kombinovan od dva materijala (drvo i aluminijum).

U postupak izbora optimalnog tipa prozora, u okviru svakog materijala doprozornika i krila prozora, varirana su dva tipa stakla (dvoslojno i troslojno). Karakteristike variranih tipova prozora prikazane su u tabelama 4 i 5 [14,15,16,17,18].

By applying the selected method, a rank list or the order of variation solutions is obtained, for the case of same and diverse weight coefficients, i.e. the final decision is reached on the selection of one variation solution.

4 MULTICRITERIA DECISION MAKING METHODOLOGY – APPLICATION

The proposed multicriteria decision making methodology has been verified on the example of selecting the most optimal window type (the optimal solution). The evaluated variations are the following:

- Timber window,
- PVC window,
- Aluminium window, and
- Two-material combination, timber-aluminium, window.

During the procedure of selecting the optimal type window, within each material for frames and sashes, two glass types (double glazing and triple glazing) are evaluated. The properties of the variation types of windows are presented in Tables 4 and 5 [14,15,16,17,18].

Tabela 4. Karakteristike prozora (doprozornik prozorsko krilo i staklo)

DOPROZORNIK I PROZORSKO KRILLO		STAKLO		
A1		<p>DRVENI od troslojnog lameliranog profila 68/80 sa radijalnom strukturom (smrča)</p> <p>$R_w = 35\text{dB (A1)}$ $R_w = 37\text{dB (A2)}$ $T_i = 60\text{god.}$</p>	 <p>dvoslojno</p>	niskoemisivno staklo LOW-E konstrukcija izostakla 4-16-LowE:4 punjeno argonom , distantni ram odbojnik ALU $\rho=71\%$
			 <p>troslojno</p>	niskoemisivno staklo LOW-E konstrukcija izostakla 4:LowE-12-4-12-LowE:4 punjeno argonom distantni ram topli ram TIG $\rho=74\%$
DOPROZORNIK I PROZORSKO KRILLO		STAKLO		
B1		<p>PVC petokomorni profil, širine 73mm sa debljinom spoljnog zida od 3mm i dve diht gume, ojačan pocinkovanim čelikom 1,2mm</p> <p>$R_w = 38\text{dB (B1)}$ $R_w = 40\text{dB (B2)}$ $T_i = 20\text{god.}$</p>	 <p>dvoslojno</p>	niskoemisivno staklo LOW-E konstrukcija izostakla 4-16-LowE:4 punjeno argonom , distantni ram odbojnik ALU $\rho=71\%$
			 <p>troslojno</p>	niskoemisivno staklo LOW-E konstrukcija izostakla 4:LowE-12-4-12-LowE:4 punjeno argonom distantni ram topli ram TIG $\rho=74\%$
B2				

Tabela 5. Karakteristike prozora (doprozornik prozorsko krilo i staklo)



DOPROZORNIK I PROZORSKO KRILO		STAKLO	
C1		<p>ALUMINIJUM Alumil M11600 Aluther Extra, povećane debljine profila i sa poliamidom na 34/38mm</p> <p>$R_w = 37\text{dB}$ (C1) $R_w = 38\text{dB}$ (C2) $T_i = 50\text{god.}$</p>	 <p>niskoemisivno staklo LOW-E konstrukcija izostakla 4-16-LowE:4 punjeno argonom, distantni ram odbojnik ALU $\rho=71\%$</p>
			 <p>niskoemisivno staklo LOW-E konstrukcija izostakla 4:LowE-12-4-12-LowE:4 punjeno argonom distantni ram topli ram TIG $\rho=74\%$</p>
C2			
DOPROZORNIK I PROZORSKO KRILO		STAKLO	
D1		<p>DRVO - ALUMINIJUM drvo troslojno lamelirano radijalne strukture sa spoljašnjom aluminijumskom oblogom</p> <p>$R_w = 38\text{dB}$ (D1) $R_w = 36\text{dB}$ (D2) $T_i = 60\text{god.}$</p>	 <p>niskoemisivno staklo LOW-E konstrukcija izostakla 4-16-LowE:4 punjeno argonom, distantni ram odbojnik ALU $\rho=71\%$</p>
			 <p>niskoemisivno staklo LOW-E konstrukcija izostakla 4:LowE-12-4-12-LowE:4 punjeno argonom distantni ram topli ram TIG $\rho=74\%$</p>
D2			

Table 4. Window characteristics (window frame and sash, and glass)

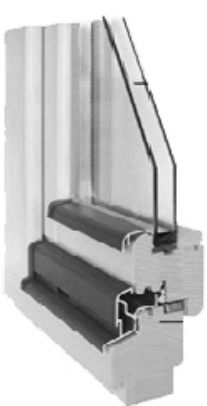
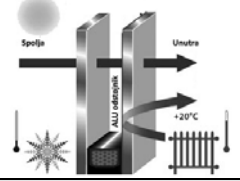
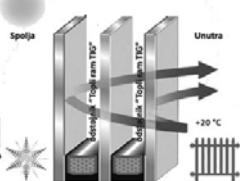
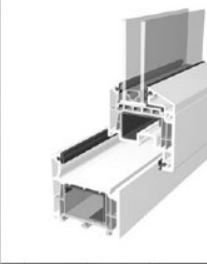
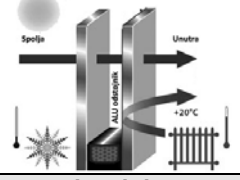
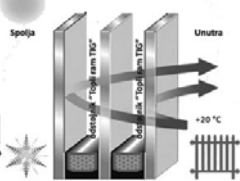
WINDOW FRAME AND SASH		GLASS	
A1		<p>TIMBER From three-layer laminated profile 68/80 with radiant structure (fir)</p> <p>$R_w = 35\text{dB}$ (A1) $R_w = 37\text{dB}$ (A2) $T_i = 60\text{yrs.}$</p>	 <p>Low-emissivity glass LOW-E Isoglass structure 4-16-LowE:4 Filled with argon, distance spacer bar aluminium $\rho=71\%$</p>
			 <p>Low-emissivity glass LOW-E Isoglass structure 4:LowE-12-4-12-LowE:4 Filled with argon, distance spacer thermal bar TIG $\rho=74\%$</p>
A2			



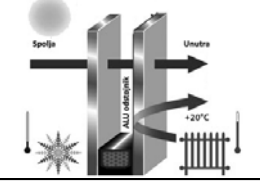
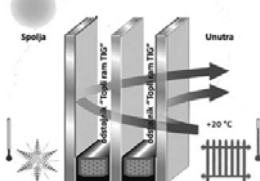

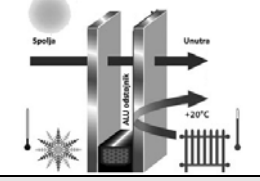
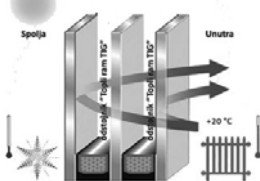
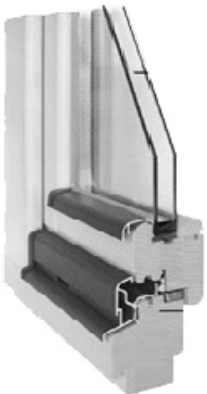
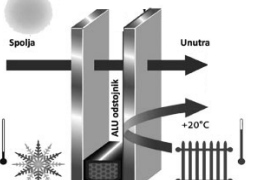
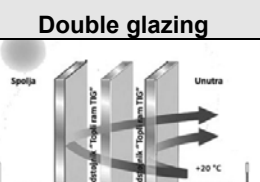
		<p>PVC Five-chamber profile, width 73mm with outer wall thickness 3mm and two rubber gaskets, strengthened with galvanized steel 1.2mm</p> <p>$R_w = 38\text{dB}$ (B1) $R_w = 40\text{dB}$ (B2) $T_i = 20\text{yrs.}$</p>	 <p>Double glazing</p>	<p>Low-emissivity glass LOW-E Isoglass structure 4-16-LowE:4 Filled with argon, distance spacer bar aluminium $\rho=71\%$</p>
B1			 <p>Triple glazing</p>	<p>Low-emissivity glass LOW-E Isoglass structure 4:LowE-12-4-12-LowE:4 Filled with argon, distance spacer thermal bar TIG $\rho=74\%$</p>
B2				

Table 5. Window characteristics (window frame and sash, and glass)

	WINDOW FRAME AND SASH		GLASS	
		<p>ALUMINIUM Alumil M11600 Aluther Extra, increased profile thickness, with polyamide at 34/38mm</p> <p>$R_w = 37\text{dB}$ (C1) $R_w = 38\text{dB}$ (C2) $T_i = 50\text{yrs.}$</p>	 <p>Double glazing</p>	<p>Low-emissivity glass LOW-E Isoglass structure 4-16-LowE:4 Filled with argon, distance spacer bar aluminium $\rho=71\%$</p>
C1			 <p>Triple glazing</p>	<p>Low-emissivity glass LOW-E Isoglass structure 4:LowE-12-4-12-LowE:4 Filled with argon, distance spacer thermal bar TIG $\rho=74\%$</p>
C2				
	WINDOW FRAME AND SASH		GLASS	
		<p>TIMBER – ALUMINIUM wood, three-layer, laminated, radiant structure with outer aluminium lining</p> <p>$R_w = 38\text{dB}$ (D1) $R_w = 36\text{dB}$ (D2) $T_i = 60\text{yrs.}$</p>	 <p>Double glazing</p>	<p>Low-emissivity glass LOW-E Isoglass structure 4-16-LowE:4 Filled with argon, distance spacer bar aluminium $\rho=71\%$</p>
D1			 <p>Triple glazing</p>	<p>Low-emissivity glass LOW-E Isoglass structure 4:LowE-12-4-12-LowE:4 Filled with argon, distance spacer thermal bar TIG $\rho=74\%$</p>
D2				

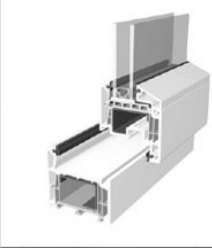
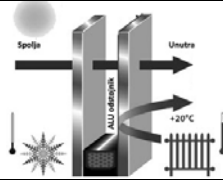
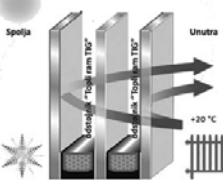
4.1 Prva faza odlučivanja – GENERISANJE MOGUĆIH REŠENJA

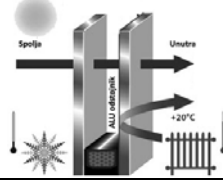
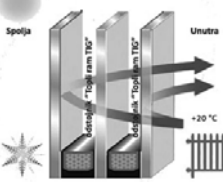
Prva faza odlučivanja – koja podrazumeva generisanje mogućih rešenja – svodi se na izbor tipova prozora čija kombinacija materijala (doprozornika, prozorskog krila i stakla) zadovoljava granične vrednosti koeficijenta prolaza toplote prozora U_w , u skladu s Pravilnikom o energetskej efikasnosti zgrada. Ulazni podaci za proračun dati su u tabeli 6, a sračunate vrednosti koeficijenta prolaza toplote prozora U_w – u tabeli 7.

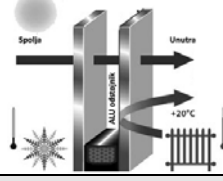
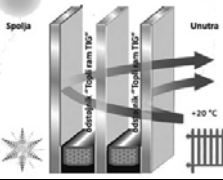
4.1 First decision making phase – GENERATING POSSIBLE SOLUTIONS

The first decision making phase, implying the generation of possible solutions, relies on the selection of window types whose combination of materials (window frames, sash and glass) satisfies the limit values of the window heat transfer coefficient U_w , in accordance with the Regulations on Energy Efficiency of Buildings. Input data for calculations are provided in Table 6, while the calculated values of the window heat transfer coefficient U_w are shown in Table 7.

Tabela 6. Ulazni podaci za proračun koeficijenta prolaza toplote prozora
Table 6. Input data for calculating the window heat transfer coefficient

PROZOR / WINDOW	KOEFICIJENT TOPLOTNE PROVODLJIVOSTI PROZORA U_w HEAT TRANSFER COEFFICIENT U_w	PODACI ZA PRORAČUN CALCULATION DATA
	$U_w = \frac{A_g \times U_g + A_f \times U_f + l_g \times \psi_g}{A_g + A_f}$ <p> A_g – površina stakla / glass area A_f – površina okvira / frame area l_g – dužina / length U_g – koef. topl. provod. stakla / glass heat transfer coefficient U_f – koef. topl. provod. okvira / frame heat transfer coefficient ψ_g – faktor korekcije temperature / temperature correlation factor - spoj staklo/okvir / joint glass/frame </p>	$A_g - 1.54\text{m}^2$ $A_f - 0.7\text{m}^2$ $l_g - 7.8\text{m}$ $\psi_g - 0.06$ (drvo / timber and PVC) $\psi_g - 0.08$ (aluminijum / aluminium)
TIP PROZORA – dvodelni DIMENZIJE prozora 140/160 WINDOW TYPE – two-casement DIMENSIONS of the window 140/160	Ograničenje / Limitation $U_w \leq U_{\max}, \quad U_{\max} = 1.5 \text{ [W/(m}^2\text{xK)]}$	

Tabela 7. Vrednosti koeficijent prolaza toplote prozora U_w
Table 7. Values of the window heat transfer coefficient U_w

	DOPROZORNIK I PROZORSKO KRILLO WINDOW FRAME AND SASH	U_f [W/(m ² xK)]	STAKLO GLASS	U_g [W/(m ² xK)]	U_w [W/(m ² xK)]
A1	DRVO TIMBER	1.5	dvoslojno double glazing	1.1	1.434
A2			troslojno triple glazing	0.7	1.159
B1	PVC	1.3	dvoslojno double glazing	1.1	1.371
B2			troslojno triple glazing	0.7	1.096
C1	ALUMINIJUM ALUMINIUM	1.5	dvoslojno double glazing	1.1	1.50
C2			troslojno triple glazing	0.7	1.229
D1	DRVO-ALUMINIJUM TIMBER-ALUMINIUM	1,4	dvoslojno double glazing	1,1	1,402
D2			troslojno triple glazing	0,7	1,128

4.2 Druga faza odlučivanja – IZBOR OPTIMALNOG TIPA PROZORA

Druga faza odlučivanja uključuje definisanje kriterijuma, vrednovanje mogućih varijanti, primenu izabrane metode optimizacije i konačan izbor najpovoljnije varijante. Početna matrica odlučivanja, s numeričkim vrednostima kriterijumskih funkcija za osam varijanti prozora, data je u tabeli 8 [16,17,19,20,21,22].

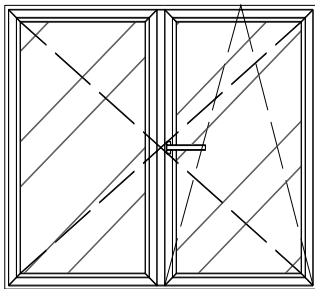
4.2 Second decision making phase – SELECTING THE OPTIMAL WINDOW TYPE

The second decision making phase includes the definition of criteria, the evaluation of possible variations, the application of the selected optimization method, and the final selection of the most optimal variation. The initial decision-making matrix, with the numerical values of criterion functions for eight window variations, is presented in Table 8 [16,17,19,20,21,22].

Tabela 8. Početna matrica odlučivanja
Table 8. Initial decision-making matrix

	A1	A2	B1	B2	C1	C2	D1	D2
f1	1.434	1.159	1.371	1.096	1.500	1.229	1.402	1.128
f2	0.29	0.260	0.29	0.260	0.29	0.260	0.29	0.260
f3	0.029	0.027	0.026	0.025	0.027	0.026	0.026	0.028
f4	268.000	336.000	224.000	290.000	403.000	448.000	493.000	672.000
f5	3.795	3.795	3.226	3.226	4.175	4.175	4.554	4.554
f6	1.000	1.000	3.000	3.000	1.200	1.200	1.000	1.000
f7	1.000	1.000	2.000	2.000	2.000	2.000	1.500	1.500

Primenom metoda višekriterijumskog odlučivanja (kompromisno programiranje i kompromisno rangiranje), dobijeni su izlazni rezultati, redosled varijanti i izabran najpovoljniji tip prozora. U postupku optimizacije, u prvom prolazu sve kriterijumske funkcije posmatrane su sa istim značajem. Izlazni rezultati, redosled varijantnih rešenja prikazan je u tabelama 9 i 10.

After applying the multicriteria decision making method (compromise programming and compromise ranking), the output results are obtained, the variations are placed in order and the most optimal window type is selected. In the optimization process in the first iteration, all criterion functions are observed with the same objective. The output results and the order of variation solutions are presented in Tables 9 and 10.

Tabela 9. Izlazni rezultati – Metoda kompromisnog programiranja
Table 9. Output results – Compromise programming method

	A1	A2	B1	B2	C1	C2	D1	D2
p = 1	5	1	6	2	8	3	7	4
p = 2	5	1	7	3	8	2	6	4
p = ∞	5	1	7	2	8	3	6	4

Tabela 10. Izlazni rezultati – Metoda kompromisnog rangiranja - isti težinski koeficijenti
Table 10. Output results – Compromise ranking method - same weight coefficients

	A1	A2	B1	B2	C1	C2	D1	D2
v=0.0	4	1	5	2	7	3	6	8
v=0.3	4	1	5	2	7	3	6	8
v=0.6	4	1	5	2	7	3	6	8
v=0.9	4	1	6	2	8	3	7	5
v=1.0	5	1	6	2	8	3	7	4

Nadalje, iskorišćene su mogućnosti metoda i uvedeni su različiti težinski koeficijenti, isticanjem značaja nekih pojedinačnih kriterijuma:

- ANALIZA I – naglašeni pokazatelji energetske efikasnosti, svetlosne propustljivosti i zvučne izolacije;
- ANALIZA II – naglašeni pokazatelji efektivnosti izgradnje (tržišna cena i vreme ugradnje prozora);
- ANALIZA III – naglašeni trajnost prozora i ekološki pokazatelj.

Further on, possibilities of the method are used and different weight coefficients are introduced, by emphasising the significance of certain individual criteria, as follows:

- ANALYSIS I – the emphasis is on the energy efficiency, light conductivity and sound insulation indicators,
- ANALYSIS II – the emphasis is on building efficiency indicators (market price and window installation time), and

Izlazni rezultati, redosled varijantnih rešenja prikazan je u tabelama 11,12 i 13.

• ANALYSIS III – the emphasis is on window duration and ecological indicator.

Output results and the order of variation solutions are shown in Tables 11, 12 and 13.

Tabela 11. Izlazni rezultati - Metoda kompromisnog rangiranja - različiti težinski koeficijenti – ANALIZA I
Table 11. Output results – Compromise ranking method different weight coefficients – ANALYSIS I

$$w_1=0.3, w_2=w_3=1.5, w_4=w_5=w_6=w_7=0.1$$

	A1	A2	B1	B2	C1	C2	D1	D2
v=0.0	7	1	4	2	8	3	5	6
v=0.3	5	1	4	2	8	3	6	7
v=0.6	3	1	4	2	7	5	6	8
v=0.9	1	2	3	4	6	5	7	8
v=1.0	1	2	3	4	5	6	7	8

Tabela 12. Izlazni rezultati - Metoda kompromisnog rangiranja - različiti težinski koeficijenti – ANALIZA II
Table 12. Output results – Compromise ranking method different weight coefficients – ANALYSIS II

$$w_1=w_2=w_3=0.1, w_4=w_5=0.25, w_6=w_7=0.1$$

	A1	A2	B1	B2	C1	C2	D1	D2
v=0.0	3	4	1	2	5	6	7	8
v=0.3	3	4	1	2	5	6	7	8
v=0.6	2	3	1	4	5	6	7	8
v=0.9	2	3	1	4	5	6	7	8
v=1.0	2	3	1	4	5	6	7	8

Tabela 13. Izlazni rezultati – Metoda kompromisnog rangiranja - različiti težinski koeficijenti – ANALIZA III
Table 13. Output results – Compromise ranking method different weight coefficients – ANALYSIS III

$$w_1=w_2=w_3=w_4=w_5=0.1, w_6=w_7=0.25$$

	A1	A2	B1	B2	C1	C2	D1	D2
v=0.0	2	1	5	8	6	7	3	4
v=0.3	2	1	5	8	6	7	3	4
v=0.6	2	1	3	8	6	7	4	5
v=0.9	2	1	3	8	6	7	4	5
v=1.0	2	1	3	8	6	7	4	5

Izlazni rezultati vrednovanja varijanti prozora pokazali su:

- primenom metode kompromisnog programiranja, s ravnopravnim učešćem svih kriterijuma, optimalna varijanta jeste prozor tipa A2 – drveni prozor s troslojnim zastakljenjem (tabela 9)

- primenom metode kompromisnog rangiranja, s ravnopravnim učešćem svih kriterijuma, optimalna varijanta jeste prozor tipa A2 – drveni prozor s troslojnim zastakljenjem (tabela 10)

- primenom metode kompromisnog rangiranja, naglašavanjem značaja pokazatelja energetske efikasnosti, svetlosne propustljivosti i zvučne izolacije (ANALIZA I) optimalna varijanta jeste – drveni prozor (tabela 11);

- a) tipa A1 – s dvoslojnim zastakljenjem (u strategiji odlučivanja u kojoj se ne dopušta potpuno nezadovoljenje bilo kog kriterijuma);

- b) tipa A2 – s troslojnim zastakljenjem (u strategiji odlučivanja koja daje prednost zadovoljenju većine kriterijuma);

- primenom metode kompromisnog rangiranja,

The output results for the evaluation of window variations demonstrate the following:

- After applying the compromise programming method, with the equal participation of all criteria, the optimal variation is the window type A2 – a timber window with triple glazing (Table 9).

- After applying the compromise ranking method, with the equal participation of all criteria, the optimal variation is the window type A2 – a timber window with triple glazing (Table 10).

- After applying the compromise ranking method, emphasising the significance of the energy efficiency, light conductivity and sound insulation indicators (ANALYSIS I), the optimal variation is a timber window (Table 11):

- a) Type A1 – with double glazing (in the decision making strategy where the complete dissatisfaction of any criteria is not permitted), and

- b) Type A2 – with triple glazing (in the decision making strategy that provides advantage to satisfying the majority of criteria).

- After applying the compromise ranking method,

naglašavanjem značaja pokazatelja efektivnosti izgradnje, tržišne cene i vremena ugradnje prozora (ANALIZA II), optimalna varijanta jeste prozor tipa B1 – PVC prozor s dvoslojnim zastakljenjem (tabela 12);

- primenom metode kompromisnog rangiranja, naglašavanjem značaja pokazatelja trajnosti i ekologije (ANALIZA III), optimalna varijanta je prozor tipa A2 – drveni prozor sa troslojnim zastakljenjem (tabela 13).

5 ZAKLJUČAK

U radu je predložena metodologija višekriterijumskog vrednovanja i odlučivanja pri izboru najpovoljnijeg tipa prozora. Model vrednovanja definisan je sa sedam raznorodnih kriterijumskih funkcija, kako bi se obuhvatili bitni aspekti koji utiču na izbor i što realnije izabrala optimalna varijanta. Iskorišćena je mogućnost uključivanja kvantitativnih i kvalitativnih kriterijuma u odlučivanje i predloženi su različiti načini vrednovanja (kvantifikacije) kvalitativnih kriterijuma.

Na bazi definisanih kriterijuma za varijantna rešenja (drveni, PVC, aluminijumski i drvo-aluminijum prozor), kombinacijom dva tipa stakla (dvoslojno ili troslojno), metodom višekriterijumske optimizacije, izabrano je optimalno rešenje. Rezultati metode višekriterijumske optimizacije, kompromisno programiranje i kompromisno rangiranje sa istim težinskim koeficijentima za sve strategije odlučivanja, pokazali su da je optimalno rešenje varijanta – drveni prozor s troslojnim staklom.

U drugom delu analize variran je značaj pojedinačnih kriterijumskih funkcija uvođenjem težinskih koeficijenata. Kada se prednost da pokazatelju energetske efikasnosti (ANALIZA I) i trajnosti i ekološkom faktoru (ANALIZA III), optimalno rešenje je takođe drveni prozor. Analiza u kojoj se naglašava značaj pokazatelja efektivnosti izgradnje (tržišna cena i vreme ugradnje - ANALIZA II), prednost daje PVC prozoru.

Izlazni rezultati optimizacije potvrdili su primenljivost metodologije višekriterijumskog odlučivanja. U predloženom modelu, izborom težinskih koeficijenata, moguće je dobiti više varijanti izlaznih rezultata, što daje dobru podlogu za objektivno odlučivanje i izbor najpovoljnijeg (optimalnog) tipa prozora. Naglašavanjem značaja pojedinih kriterijumskih funkcija, moguće je tok odlučivanja uskladiti s postavljenim ciljem optimizacije.

ZAHVALNOST

U radu je prikazan deo istraživanja koje je pomoglo Ministarstvo za nauku i tehnološki razvoj Republike Srbije, u okviru tehnološkog projekta TR 36017, pod nazivom: „Istraživanje mogućnosti primene otpadnih i recikliranih materijala u betonskim kompozitima, sa ocenom uticaja na životnu sredinu, u cilju promocije održivog građevinarstva u Srbiji”.

emphasising the significance of building efficiency indicators, market price and window installation time (ANALYSIS II), the optimal variation is the window type B1 – a PVC window with double glazing (Table 12), and

- After applying the compromise ranking method, emphasising the significance of durability and ecology indicators (ANALYSIS III), the optimal variation is the window type A2 – a timber window with triple glazing (Table 13).

5 CONCLUSION

The paper proposes multicriteria evaluation and decision making methodology for selecting the most optimal window type. The evaluation model is defined with seven diverse criterion functions in order to encircle the important aspects that influence the selection, hence choosing the optimal variation as close to realistic as possible. The method utilized the possibility to include quantitative and qualitative criteria in the decision making process and diverse evaluation methods (quantifications) of the qualitative criteria are proposed.

Based on the defined criteria for variation solutions (timber, PVC, aluminium and timber-aluminium window), and combination of two glass types (double glazing and triple glazing), the multicriteria optimization method provides help in selecting the optimal solution. The results of the multicriteria optimization method, compromise programming, and compromise ranking with the same weight coefficients for all decision making strategies, demonstrate that the optimal solution is the following variation – a timber window with triple glazing.

In the second part of the analysis, the significance of individual criterion functions is varied by introducing weight coefficients. When the advantage is attributed to the energy efficiency indicator (ANALYSIS I) and the durability and ecological indicator (ANALYSIS III), the optimal solution is also a timber window. The analysis where the significance is attributed to the building efficiency indicator (market price and installation time – ANALYSIS II), states that the advantage goes to a PVC window.

Output optimization results confirm the applicability of the multicriteria decision making methodology. In the proposed model, by selecting the weight coefficients, it is possible to obtain more variations of the output results, providing a good foundation for objective decision making and the selection of the most optimal window type. By emphasising the significance of individual criterion functions, it is possible to synchronise the decision making process with the set optimization goals.

ACKNOWLEDGEMENT

The work reported in this paper is a part of the investigation within the research project TR 36017 "Utilization of by-products and recycled waste materials in concrete composites in the scope of sustainable construction development in Serbia: investigation and environmental assessment of possible applications", supported by the Ministry for Science and Technology, Republic of Serbia. This support is gratefully acknowledged.

6 LITERATURA REFERENCES

- [1] Zbirka tehničkih propisa, tehničkih uslova, mera i normativa u građevinarstvu 2, Građevinska knjiga, Beograd, 1980.
- [2] Mitrović, R.: Energy efficiency and glass technology used in architectural designs, Časopis Materijali i konstrukcije 53 (2010), 3 (44-53).
- [3] Normativi i standardi rada u građevinarstvu, Građevinska knjiga, Beograd, 1985.
- [4] Opricović, S. : Optimizacija sistema, Građevinski fakultet, Beograd, 1992.
- [5] Opricović, S. Višekriterijumska optimizacija sistema u građevinarstvu. Građevinski fakultet Univerziteta u Beogradu, Beograd, 1998.
- [6] Pravilnik o energetskej efikasnosti zgrada, Sl. glasnik RS br.61/11
- [7] Standard SRPS EN ISO 10077-1 Toplotne performanse prozora, vrata i kapaka-proračun koeficijenata prolaza toplote - deo 1 - opšte, Institut za standardizaciju Srbije, 2008.
- [8] Standard SRPS EN ISO 10077-2 Toplotne performanse prozora, vrata i kapaka-proračun koeficijenata prolaza toplote - deo 2 - numerička metoda za okvir, Institut za standardizaciju Srbije, 2013..
- [9] Standardi SRPS ISO 140 Akustika - merenje zvučne izolacije u zgradama i zvučne izolacije građevinskih elemenata, Institut za standardizaciju Srbije, 2005.
- [10] <http://www.pvcinzingering.co.rs/cenovnik-aluminijumskih-prozora.html>
- [11] Standard SRPS EN ISO 14351-1 Prozori i vrata, standard za proizvod karakteristike i performanse - deo 1, Institut za standardizaciju Srbije, 2011.
- [12] Harmati, N., Folić, R., Magyar, Z.: Energy performance modelling and heat recovery unit efficiency assessment of an office building, Thermal Science, 2015, DOI REF:10.2298/TSCI140311102H, <http://thermalscience.vinca.rs/online-first/1363>
- [13] Štromar, Ž., Zagorec, M.: Tehnički uvjeti, odabir i ispitivanje prozora prije ugradnje, Časopis Građevinar 61(2009), 12 (1153-1161).
- [14] <http://www.unidas.co.rs/download/Tabela-prednosti-razlike-stolarije.pdf>
- [15] <http://www.dualstolarija.com/staklo/tipovi-stakala>
- [16] http://www.hram032.rs/dvokrilni_prozori.html
- [17] <http://www.drvoalu.com/drveni-prozori/>
- [18] <http://www.drvoalu.com/prozori/>
- [19] <http://www.tim-bg.co.rs/stolarija-alu-portali-sa-termo-prekinutim-mostom>
- [20] <http://www.hram032.rs/pdf/cenovnik-salamander-exclusive.pdf>
- [21] <http://www.pvc-stolarija-beozan.com/cene.html>
- [22] <http://www.ibcapital.rs/cenovnik>

REZIME

VIŠEKRITERIJUMSKO VREDNOVANJE I IZBOR PROZORA

Jasmina DRAŽIĆ
Mirjana LABAN

Izbor prozora koji objedinjuje i ispunjava zahteve korisnika zgrade, projektanta i izvođača radova, podrazumeva višekriterijumsku analizu. U radu je prikazana metodologija višekriterijumskog odlučivanja, kojom se dolazi do najpovoljnije varijante (tipa prozora). Definisana je model optimizacije sa sedam kriterijumskih funkcija i izabrana adekvatna metoda optimizacije. Metodologija je potvrđena na primeru izbora jedne od osam varijanti prozora. Usvojena metoda, izborom težinskih koeficijenata, donosi odluku predlaže više različitih izlaznih rezultata i pruža mogućnost usvajanja konačnog (optimalnog) rešenja, usklađenog sa ciljem optimizacije.

Ključne reči: prozor, višekriterijumsko odlučivanje, optimizacija, varijante, kriterijum, metoda

SUMMARY

MULTICRITERIA EVALUATION AND WINDOW SELECTION

Jasmina DRAŽIĆ
Mirjana LABAN

The selection of windows that joins and fulfils demands by the building's users, designers and contractors implies the multicriteria analysis. The paper presents the multicriteria decision making methodology for achieving the most optimal variation (type of window). The optimization model is defined with seven criterion functions and the adequate optimization method is selected. The methodology is confirmed on an example of a selection of one out of eight window variations. The adopted method, by selecting the weight coefficients, proposes to the decision maker several different output results and offers the possibility to adopt the final (optimal) solution that is in accordance with the optimization goal.

Key words: window, multicriteria decision making, optimization, variations, criterion, method

UPUTSTVO AUTORIMA*

Prihvatanje radova i vrste priloga

U časopisu Materijali i konstrukcije štampaće se neobjavljeni radovi ili članci i konferencijska saopštenja sa određenim dopunama ili bez dopuna, prema odluci Redakcionog odbora, a samo izuzetno uz dozvolu prethodnog izdavača prihvatice se i objavljeni rad. Vrste priloga autora i saradnika koji će se štampati su: originalni naučni radovi, prethodna saopštenja, pregledni radovi, stručni radovi, konferencijska saopštenja (radovi sa naučno-stručnih skupova), kao i ostali prilozi kao što su: prikazi objekata i iskustava - primeri, diskusije povodom objavljenih radova i pisma uredništvu, prikazi knjiga i zbornika radova, kao i obaveštenja o naučno-stručnim skupovima.

Originalni naučni rad je primarni izvor naučnih informacija i novih ideja i saznanja kao rezultat izvornih istraživanja uz primenu adekvatnih naučnih metoda. Dobijeni rezultati se izlažu kratko, jasno i objektivno, ali tako da poznavalac problema može proceniti rezultate eksperimentalnih ili teorijsko numeričkih analiza i tok razmišljanja, tako da se istraživanje može ponoviti i pri tome dobiti iste ili rezultate u okvirima dopuštenih odstupanja, kako se to u radu navodi.

Prethodno saopštenje sadrži prva kratka obaveštenja o rezultatima istraživanja ali bez detaljnih objašnjenja, tj. kraće je od originalnog naučnog rada. U ovu kategoriju spadaju i diskusije o objavljenim radovima ako one sadrže naučne doprinose.

Pregledni rad je naučni rad koji prikazuje stanje nauke u određenoj oblasti kao plod analize, kritike i komentara i zaključaka publikovanih radova o kojima se daju svi neophodni podaci pregledno i kritički uključujući i sopstvene radove. Navode se sve bibliografske jedinice korišćene u obradi tematike, kao i radovi koji mogu doprineti rezultatima daljih istraživanja. Ukoliko su bibliografski podaci metodski sistematizovani, ali ne i analizirani i raspravljani, takvi pregledni radovi se klasifikuju kao stručni pregledni radovi.

Stručni rad predstavlja koristan prilog u kome se iznose poznate spoznaje koje doprinose širenju znanja i prilagođavanja rezultata izvornih istraživanja potrebama teorije i prakse. On sadrži i rezultate razvojnih istraživanja.

Konferencijsko saopštenje ili rad saopšten na naučno-stručnom skupu koji mogu biti objavljeni u izvornom obliku ili ih autor, u dogovoru sa redakcijom, bitno preradi i proširi. To mogu biti naučni radovi, naročito ako su saopštenja po pozivu Organizatora skupa ili sadrže originalne rezultate prvi put objavljene, pa ih je korisno uz određene dopune učiniti dostupnim široj stručnoj javnosti. Štampaće se i stručni radovi za koje Redakcioni odbor oceni da su od šireg interesa.

Ostali prilozi su prikazi objekata, tj. njihove konstrukcije i iskustava-primeri u građenju i primeni različitih materijala, diskusije povodom objavljenih radova i pisma uredništvu, prikazi knjiga i zbornika radova, kao i obaveštenja o naučno-stručnim skupovima.

Autori uz rukopis predlažu kategorizaciju članka. Svi radovi pre objavljivanja se recenziraju, a o prihvatanju za publikovanje o njihovoj kategoriji konačnu odluku donosi Redakcioni odbor.

Da bi se ubrzao postupak prihvatanja radova za publikovanje, potrebno je da autori uvažavaju Uputstva za pripremu radova koja su navedena u daljem tekstu.

Uputstva za pripremu rukopisa

Rukopis otkucati jednostrano na listovima A-4 sa marginama od 31 mm (gore i dole) a 20 mm (levo i desno), u Wordu fontom Arial sa 12 pt. Potrebno je uz jednu kopiju svih delova rada i priloga, dostaviti i elektronsku verziju na navedene E-mail adrese, ili na CD-u. Autor je obavezan da čuva jednu kopiju rukopisa kod sebe zbog eventualnog oštećenja ili gubitka rukopisa.

Od broja 1/2010. prema odluci Upravnog odbora Društva i Redakcionog odbora, radovi sa pozitivnim recenzijama i prihvaćeni za štampu, publikovaće se na srpskom i engleskom jeziku.

Svaka stranica treba da bude numerisana, a optimalni obim članka na jednom jeziku je oko 16 stranica (30000 slovnih mesta) uključujući slike, fotografije, tabele i popis literature. Za radove većeg obima potrebna je saglasnost Redakcionog odbora.

Naslov rada treba sa što manje reči (poželjno osam, a najviše do jedanaeset) da opiše sadržaj članka. U naslovu ne koristiti skraćenice ni formule. U radu se iza naslova daju ime i prezime autora, a titule i zvanja, kao i ime institucije u podnožnoj napomeni. Autor za kontakt daje telefone, faks i adresu elektronske pošte, a za ostale autore poštansku adresu.

Uz sažetak (rezime) od oko 150 do 200 reči, na srpskom i engleskom jeziku daju se ključne reči (do deset). To je jezgrovit prikaz celog članka i čitaocima omogućuje uvid u njegove bitne elemente.

Rukopis se deli na poglavlja i potpoglavlja uz numeraciju, po hijerarhiji, arapskim brojevima. Svaki rad ima uvod, sadržinu rada sa rezultatima, analizom i zaključcima. Na kraju rada se daje popis literature.

Kod svih dimenzionalnih veličina obavezna je primena međunarodnih SI mernih jedinica.

Formule i jednačine treba pisati pažljivo vodeći računa o indeksima i eksponentima. Autori uz izraze u tekstu definišu simbole redom kako se pojavljuju, ali se može dati i posebna lista simbola u prilogu.

Prilozi (tabele, grafikoni, sheme i fotografije) rade se u crno-belom tehničkom, u formatu koji obezbeđuje da pri smanjenju na razmere za štampu, po širini jedan do dva stupca (8cm ili 16.5cm), a po visini najviše 24.5cm, ostanu jasni i čitljivi, tj. da veličine slova i brojeva budu najmanje 1.5mm. Originalni crteži treba da budu kvalitetni i u potpunosti pripremljeni za presnimavanje. Mogu biti i dobre, oštre i kontrastne fotokopije. Koristiti fotografije, u crno-belom tehničkom, na kvalitetnoj hartiji sa oštrim konturama, koje omogućuju jasnu reprodukciju. Skraćenice u prilogima koristiti samo izuzetno uz obaveznu legendu. Prilozi se posebno označavaju arapskim brojevima, prema redosledu navođenja u tekstu. Objašnjenje tabela daje se u tekstu.

Potrebno je dati spisak svih skraćenica korišćenih u tekstu.

U popisu literature na kraju rada daju se samo oni radovi koji se pominju u tekstu. Citirane radove treba prikazati po azbučnom redu prezimena prvog autora. Literaturu u tekstu označiti arapskim brojevima u uglastim zagradama, kako se navodi i u Popisu citirane literature, napr [1]. Svaki citat u tekstu mora se naći u Popisu citirane literature i obrnuto svaki podatak iz Popisa se mora navesti u tekstu.

U Popisu literature se navode prezime i inicijali imena autora, zatim potpuni naslov citiranog članka, iza toga sledi ime časopisa, godina izdavanja i početna i završna stranica (od - do). Za knjige iza naslova upisuje se ime urednika (ako ih ima), broj izdanja, prva i poslednja stranicapoglavlja ili dela knjige, ime izdavača i mesto objavljivanja, ako je navedeno više gradova navodi se samo prvi po redu. Kada autor citirane podatke ne uzima iz izvornog rada, već ih je pronašao u drugom delu, uz citat se dodaje «citirano prema...». Neobjavljeni članci mogu se pominjati u tekstu kao «usmeno saopštenje».

Autori su odgovorni za izneseni sadržaj i moraju sami obezbediti eventualno potrebne saglasnosti za objavljivanje nekih podataka i priloga koji se koriste u radu.

Ukoliko rad bude prihvaćen za štampu, autori su dužni da, po uputstvu Redakcije, unesu sve ispravke i dopune u tekstu i prilogima.

Za detaljnija tehnička uputstva za pripremu rukopisa autori se mogu obratiti Redakcionom odboru časopisa.

Rukopisi i prilozi objavljenih radova se ne vraćaju. Sva eventualna objašnjenja i uputstva mogu se dobiti od Redakcionog odbora.

Radovi se mogu slati i na e-mail: folic@uns.ac.rs ili miram@uns.ac.rs i dimk@ptt.rs

Već sajt Društva i časopisa: www.dimk.rs

* Uputstvo autorima je modifikovano i treba ga u pripremi radova slediti.

Izdavanje časopisa "Građevinski materijali i konstrukcije" finansijski su pomogli:



INŽENJERSKA KOMORA SRBIJE



**REPUBLIKA SRBIJA
MINISTARSTVO PROSVETE, NAUKE I
TEHNOLOŠKOG RAZVOJA**



**UNIVERZITET U BEOGRADU
GRAĐEVINSKI FAKULTET**



**DEPARTMAN ZA GRAĐEVINARSTVO
FAKULTET TEHNIČKIH NAUKA NOVI SAD**



INSTITUT IMS AD, BEOGRAD



**UNIVERZITET CRNE GORE
GRAĐEVINSKI FAKULTET - PODGORICA**